

TBM™ 2G Frameless Motor

Selection Guide

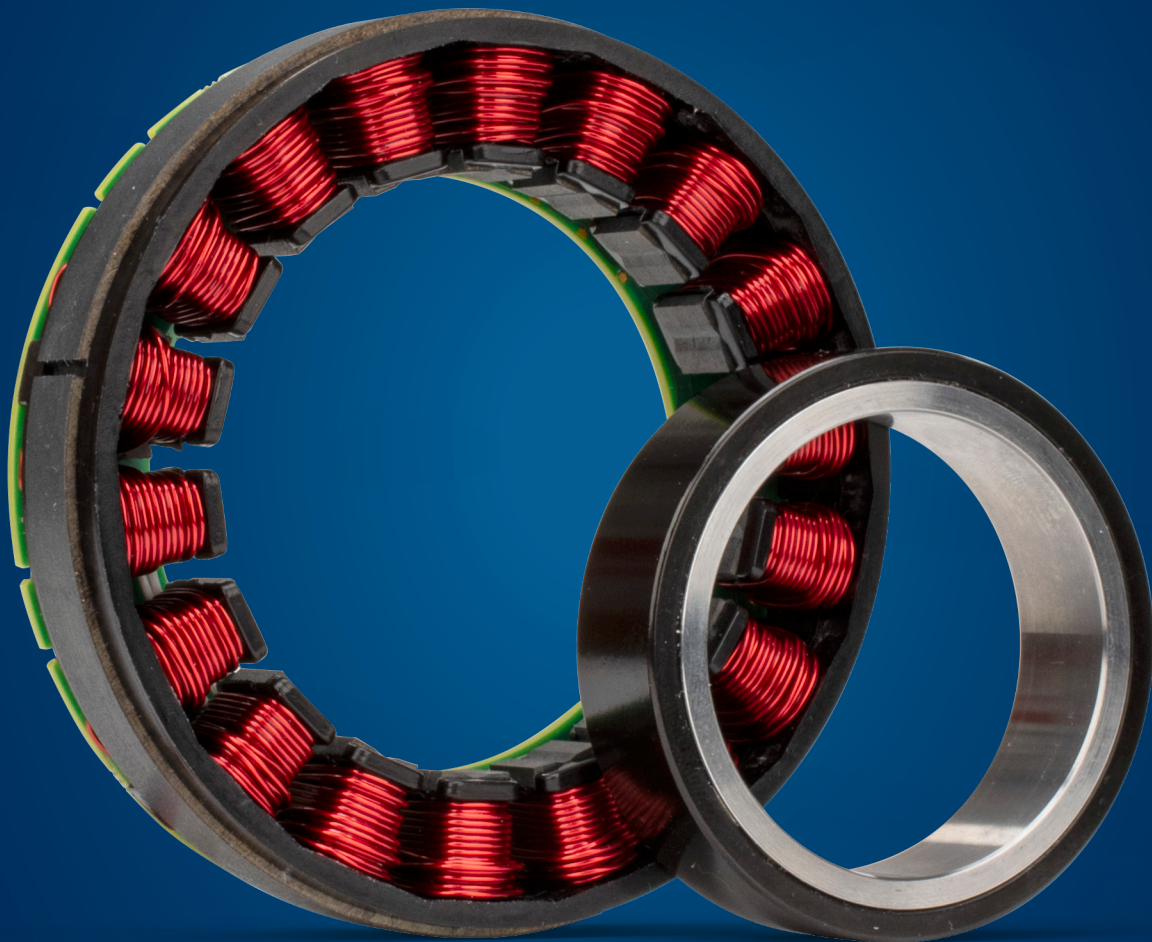

KOLLMORGEN

Kollmorgen: Your Partner, In Motion.

Every solution comes from a real understanding of the challenges facing machine designers and users.

Innovators consistently rate Kollmorgen as one of their best motion systems manufacturing partners. Whether you are looking for classic servo motors, direct-drive servo motors, stepper motors, drives & amplifiers, gearing, actuation, or multi-axis motion controllers, Kollmorgen is one of the few companies in the world that actually designs and manufactures all of these products.

Our customers are leaders in many industries such as Aerospace & Defense, Printing, Packaging & Converting, Food & Beverage Processing, Medical Imaging, In Vitro Diagnostics & Laboratory Automation, Pharmaceutical Manufacturing, Material Forming and Cutting, Oil & Gas, and Robotics. Kollmorgen is also a leader in Warehouse Automation, including complete AGV systems, software, awareness and autonomy.

Our Automation Solutions can be found on Mars and in space, ships and submarines, O&G drilling and metrology, surgical robots and laser eye surgery, even inside artificial hearts. These are just a few applications that demand high-performance and high-quality while satisfying their specific needs.

Because motion matters, it's our focus: Motion can distinctly differentiate a specific machine and deliver a marketplace advantage by increasing its performance and dramatically improving Overall Equipment Effectiveness (OEE).

High-performance motion can make your customer's machine more reliable and energy-efficient, enhance accuracy and improve operator safety. Motion also represents endless possibilities for innovation.

We've always understood this potential, and thus have kept motion at our core and in our Vision, Mission & Values, relentlessly developing products that offer precise control of torque, velocity and position accuracy in machines that rely on complex motion.

Removing the Barriers of Design, Sourcing, and Time

At Kollmorgen, we know that OEM engineers can achieve a lot more when obstacles aren't in the way. So, we clear obstacles in three important ways:

Integrating Standard and Custom Products

The optimal solution is often not clear-cut. Our application expertise allows us to modify standard products or develop totally custom solutions across our whole product portfolio so that designs can take flight.

Providing Motion Solutions, Not Just Components

As companies reduce their supplier base and focus their engineering manpower on the product design, they need a total system supplier with a wide range of integrated solutions. Kollmorgen offers complete solutions as well as motion subsystems that combine programming software, engineering services and best-in-class motion components.

Global Footprint

With direct sales, engineering support, manufacturing facilities, and distributors spanning the Americas, Europe, the Middle East, and Asia, we're close to OEMs worldwide. Our proximity helps speed delivery and lend support where and when they're needed.

Financial and Operational Stability

Kollmorgen is part of Altra Industrial Motion. A key driver in the growth of all Altra divisions is the Altra Business System, which relies on the principle of "kaizen" – or continuous improvement. Using world-class tools, cross-disciplinary teams of exceptional people evaluate processes and develop plans that result in superior performance.

Kollmorgen: Your partner. In Motion.**Trademarks**

AKD is a registered trademark of Kollmorgen Corporation
 AKM is a registered trademark of Kollmorgen Corporation
 Cartridge DDR is a registered trademark of Kollmorgen Corporation
 EnDat is a registered trademark of Dr. Johannes Heidenhain GmbH
 EtherCAT is a registered trademark and patented technology, licensed by Beckhoff Automation GmbH
 Ethernet/IP is a registered trademark of ODVA, Inc.
 Ethernet/IP Communication Stack: copyright (c) 2009, Rockwell Automation
 sercos® is a registered trademark of sercos® international e.V.
 HIPERFACE and HIPERFACE DSL are registered trademarks of Max Stegmann GmbH
 PROFINET is a registered trademark of PROFIBUS and PROFINET International (PI)
 SIMATIC is a registered trademark of SIEMENS AG
 SpeedTec, ytec, itec and htec are registered trademarks of TE Connectivity Ltd.
 Windows is a registered trademark of Microsoft Corporation

Table of Contents

▶ TBM2G Frameless Motor	4
The Benefits of TBM2G Frameless Motors	5
TBM2G Product Features	6
Torque Range and Performance Overviews	7
▶ TBM2G Nomenclature	8
▶ Available TBM2G Modifications	9
▶ TBM2G 50 Series Motor	10
Performance Data, Motor Parameters	
Performance Curves, Dimensional Drawings,	
Optional Leads Specifications	
▶ TBM2G 60 Series Motor	16
Performance Data, Motor Parameters	
Performance Curves, Dimensional Drawings,	
Optional Leads Specifications	
▶ TBM2G 68 Series Motor	22
Performance Data, Motor Parameters	
Performance Curves, Dimensional Drawings,	
Optional Leads Specifications	
▶ TBM2G 76 Series Motor	28
Performance Data, Motor Parameters	
Performance Curves, Dimensional Drawings,	
Optional Leads Specifications	
▶ TBM2G 85 Series Motor	34
Performance Data, Motor Parameters	
Performance Curves, Dimensional Drawings,	
Optional Leads Specifications	
▶ TBM2G 94 Series Motor	40
Performance Data, Motor Parameters	
Performance Curves, Dimensional Drawings,	
Optional Leads Specifications	
▶ TBM2G 115 Series Motor	46
Performance Data, Motor Parameters	
Performance Curves, Dimensional Drawings,	
Optional Leads Specifications	
▶ Leads Connection Diagrams	52
▶ Thermal Sensor Protective Devices	53
▶ Kollmorgen Solutions	55
Automation and Motion Control	
Self-help Tools	

TBM2G Series Frameless Motor

TBM2G motors deliver next-generation torque in a more compact electromagnetics package. Designed for direct embedding in your machine, these 48 VDC motors help you engineer each axis to be smaller, lighter, stronger, faster, smoother.

TBM2G: Ready to Do More.

Ready to Perform. TBM2G motors deliver significantly higher torque density in a more compact form factor. And they incorporate advanced materials and windings for more consistent performance across all speeds and torque demands. Achieve faster, smoother movements in a lighter, more compact motor with higher load capacity, greater energy efficiency and lower thermal rise.

Ready to Design. With an exceptionally short total height and a large thru-bore, TBM2G motors are ideal for applications that require high torque in a compact axial design. Seven frame sizes, each with three winding stack options, provide 21 options to achieve an ideal fit. These motors are optimized to pair with off-the-shelf harmonic gearing designs without modification.

Ready to Scale. There's no need to risk supply and quality issues. Kollmorgen has highly automated manufacturing processes in place to manufacture TBM2G motors in quantity, including standard modifications to meet your specifications. When you are ready to scale up to full production, we can supply the motors you need with assurance of quality and consistency.



The Benefits of TBM2G Frameless Motors

Ready to Deliver More

- » Seven most popular frame sizes used in embedded applications such as collaborative and surgical robots.
- » Standard sizing optimized to pair with off-the-shelf harmonic gearing.
- » Three winding options per frame size to meet precise speed and torque requirements.
- » Optimized for operation at 48 VDC and below, ideal for battery-operated and mobile applications such as autonomous mobile robots (AMR).
- » Designed to perform well without exceeding 85°C, but also capable of sustaining full performance at up to 155°C winding temperature on a continuous basis.
- » Large inner diameter thru-bore to accommodate encoders, cables, hoses, shafts, tools, etc.
- » Optional integrated Hall sensors that don't increase motor length.
- » Multiple standard thermal sensor options.

Ready to Partner for Your Success

- » Automated processes to rapidly scale from prototype to mass production.
- » Highly precise manufacturing for consistent performance.
- » Global manufacturing and distribution.
- » Local application support and service.
- » Co-engineering expertise to help you achieve ideal specifications and fit.
- » The resources and commitment to ensure consistent supply for years to come.
- » More than a century of motion leadership and innovation.

TBM2G Series Frameless Motor

TBM2G Product Features

- 7 frame sizes with 3 stack lengths each
- Integrated Hall sensor option
- PT1000 and PTC thermal sensor options
- Available with or without flying leads
- Low cogging design
- Optimized for high efficiency across a wide speed range
- Three standard winding options per frame/stack
- Stainless steel yoke rings for corrosion protection

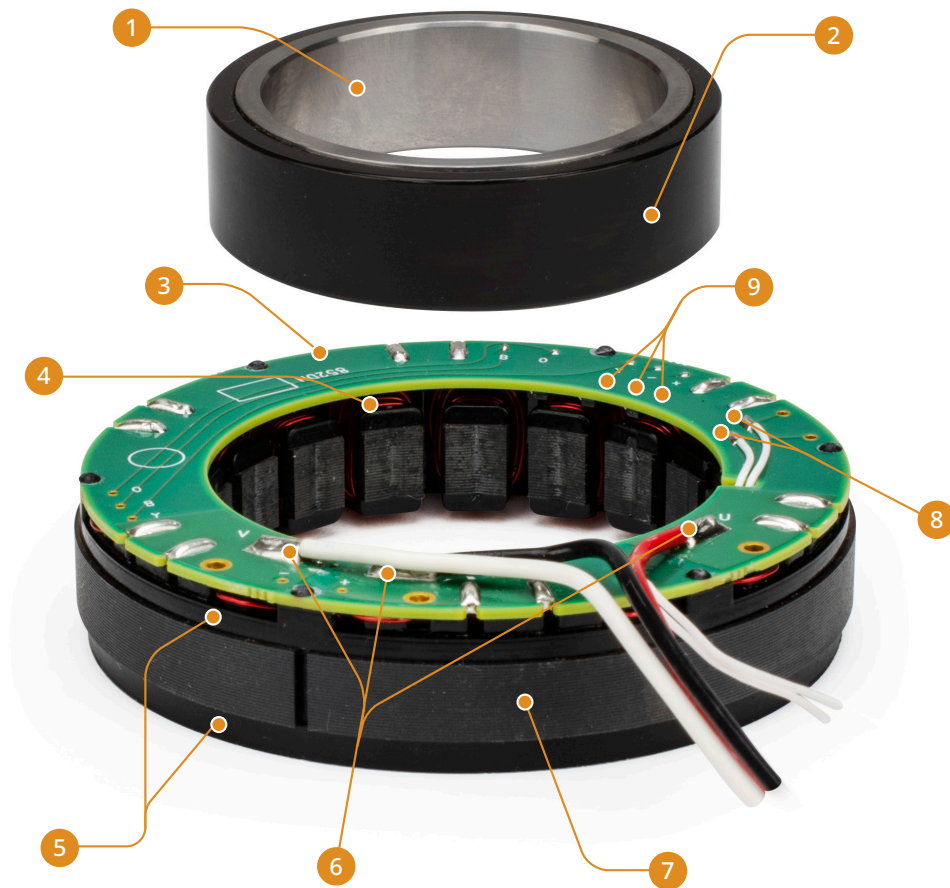

- 1** Yoke
 - Material: 400 Series Stainless Steel
- 2** Ring Magnet
 - Material: NdFeB (Neodymium)
 - Coating: Epoxy
- 3** Printed Circuit Board (PCB)
- 4** Coil
 - Material: Copper
 - Coating: Varnish
- 5** End Insulators
 - Material: Polymer Resin
- 6** Power Leads
- 7** Lamination Stack
 - Material: Electrical Steel
- 8** Optional Thermal Devices (mounted underneath PCB)
 - PT1000
 - PTC Avalanche (3 in series)
- 9** Optional Hall Sensors (mounted underneath PCB)
 - Allegro A1260

Torque Range Per Frame Size Overview

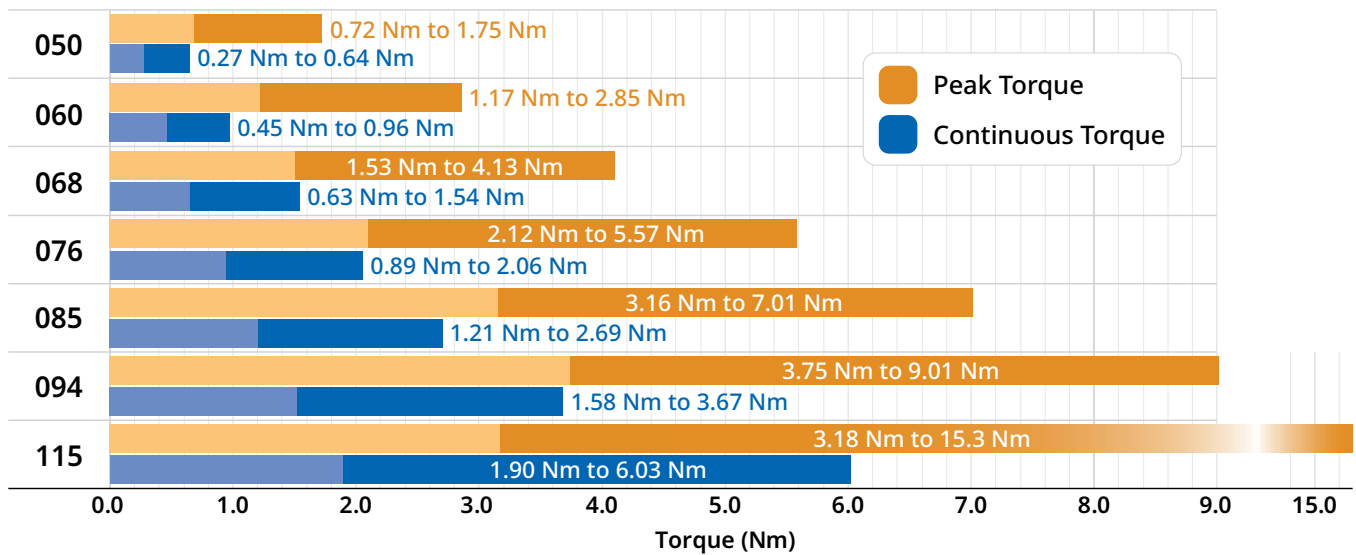

Performance Overview

			Frame											
			TBM2G-050xx			TBM2G-060xx			TBM2G-068xx			TBM2G-076xx		
Parameters	Sym	Units	08	13	26	08	13	26	08	13	26	08	13	26
Continuous Torque at Stall	T_c	Nm	0.27	0.38	0.64	0.45	0.60	0.96	0.63	0.86	1.54	0.89	1.23	2.06
		lb-in	2.39	3.33	5.62	3.97	5.30	8.54	5.60	7.64	13.6	7.85	10.9	18.2
Rated Speed	N_{rtd}	rpm	8000	8000	6600	8000	8000	4400	8000	6900	3400	8000	5600	2800
Motor Constant	K_m	Nm/ \sqrt{W}	0.061	0.082	0.128	0.087	0.114	0.176	0.119	0.157	0.251	0.156	0.201	0.324
		lb-in/ \sqrt{W}	0.54	0.73	1.13	0.77	1.01	1.56	1.05	1.39	2.22	1.38	1.78	2.87
Rated Power	P_{rtd}	kW	0.205	0.271	0.363	0.329	0.415	0.380	0.468	0.561	0.521	0.586	0.601	0.544
		Hp	0.274	0.364	0.487	0.442	0.556	0.510	0.627	0.753	0.699	0.786	0.806	0.729

			Frame								
			TBM2G-085xx			TBM2G-094xx			TBM2G-115xx		
Parameters	Sym	Units	08	13	26	08	13	26	08	13	26
Continuous Torque at Stall	T_c	Nm	1.21	1.65	2.69	1.58	2.05	3.67	1.90	3.04	6.03
		lb-in	10.7	14.6	23.8	14.0	18.1	32.5	16.8	26.9	53.3
Rated Speed	N_{rtd}	rpm	7500	5300	2600	8000	5900	2700	5800	4900	3100
Motor Constant	K_m	Nm/ \sqrt{W}	0.203	0.271	0.419	0.263	0.331	0.528	0.310	0.464	0.802
		lb-in/ \sqrt{W}	1.79	2.40	3.70	2.33	2.93	4.67	2.74	4.10	7.09
Rated Power	P_{rtd}	kW	0.717	0.734	0.650	0.860	0.874	0.897	0.711	0.969	1.430
		Hp	0.962	0.985	0.871	1.153	1.172	1.203	0.954	1.300	1.922

TBM2G Frameless Motor Nomenclature

TBM2G Frameless Motor

TBM2G - 060 08 A - N N A A - 00

Frame Size

050	50 mm OD
060	60 mm OD
068	68 mm OD
076	76 mm OD
085	85 mm OD
094	94 mm OD
115	115 mm OD

Stack Length

08	8.2 mm Stack
13	12.7 mm Stack
26	26.3 mm Stack

Winding

A to Z

Custom Options

00	Standard
01, 02, 03...	Special

Field Options

A	Standard
S	Special

Connection Options

A	0.5 m Length
N	No Leads
S	Special

Sensor Options

A	Hall Device Sensor (alt. loc.) Not available on 050 Frame
H	Hall Device Sensor
N	No Halls
S	Special

Thermal Device

A	PT1000
B	3x PTC Devices
N	No Device
S	Special

Available TBM2G Modifications

The following modifications allow our customers to optimize the base model configuration to meet the unique challenges of their application needs. Please consult Kollmorgen Customer Support for information, pricing, and feasibility of desired modifications. Engineering and soft tooling fees may be required. Additional lead time required.

Installation Features

- » Rotor Hub Geometry Smaller Bores, Keyway, Flat, Bolt holes, etc.
- » Leads: Custom Lengths, Connectorized lead assemblies, etc.

TBM2G 50 Series Motor

TBM2G 50 Series Performance Data

Parameter	Tol	Symbol	Units	TBM2G-05008			TBM2G-05013			TBM2G-05026		
				A	C	D	A	C	D	A	C	D
Rated Equivalent Line Voltage ⑥⑧		V _{bus}	Vdc	48	48	48	48	48	48	48	48	48
Max Cont. Torque for ΔT wdg. = 130°C ①④⑥⑧		T _{mc1}	Nm	0.27	0.27	0.27	0.38	0.38	0.38	0.64	0.64	0.64
			lb-in	2.39	2.39	2.39	3.39	3.33	3.33	5.66	5.62	5.62
Max Cont. Current for ΔT wdg. = 130°C ①④⑥⑧		I _{mc1}	Arms	3.31	6.61	11.5	3.09	6.08	10.5	2.59	5.18	8.96
Max Cont. Torque for ΔT wdg. = 60°C ②④⑥⑧		T _{mc2}	Nm	0.20	0.20	0.20	0.30	0.29	0.29	0.48	0.48	0.48
			lb-in	1.76	1.76	1.76	2.61	2.57	2.57	4.28	4.28	4.28
Max Cont. Current for ΔT wdg. = 60°C ②④⑥⑧		I _{mc2}	Arms	2.30	4.59	7.95	2.25	4.43	7.67	1.86	3.73	6.45
Max mechanical speed		N _{max}	rpm	8000	8000	8000	8000	8000	8000	8000	8000	8000
Peak Torque ①④		T _p	Nm	0.72	0.72	0.72	1.03	1.01	1.01	1.74	1.75	1.75
			lb-in	6.4	6.4	6.4	9.1	9.0	9.0	15.4	15.5	15.5
Peak Current ⑥⑧		I _p	Arms	9.9	19.8	34.2	9.2	18.2	31.5	7.7	15.5	26.8
24 Vdc@85°C												
Rated Torque (speed) ②③		T _{rttd}	Nm	0.19	0.17	0.16	0.28	0.26	0.23	0.47	0.45	0.41
			lb-in	1.67	1.55	1.43	2.51	2.30	2.05	4.18	3.96	3.64
Rated Speed		N _{rttd}	rpm	2300	5200	8000	1400	3400	6300	600	1600	3100
Rated Power (speed) ②③		P _{rttd}	kW	0.045	0.095	0.135	0.042	0.092	0.153	0.030	0.075	0.134
			Hp	0.061	0.128	0.181	0.056	0.124	0.205	0.040	0.101	0.179
24 Vdc@155°C												
Rated Torque (speed) ①③		T _{rttd}	Nm	0.27	0.26	0.24	0.38	0.36	0.34	0.63	0.62	0.59
			lb-in	2.35	2.26	2.17	3.34	3.17	2.99	5.59	5.45	5.21
Rated Speed		N _{rttd}	rpm	1800	4900	8000	1100	3100	6100	300	1400	2900
Rated Power (speed) ①③		P _{rttd}	kW	0.050	0.131	0.205	0.043	0.116	0.216	0.020	0.090	0.179
			Hp	0.067	0.176	0.275	0.058	0.156	0.290	0.027	0.121	0.240
48 Vdc@85°C												
Rated Torque (speed) ②③		T _{rttd}	Nm	0.17	0.16	0.16	0.26	0.22	0.21	0.45	0.40	0.33
			lb-in	1.55	1.43	1.42	2.34	1.97	1.90	3.96	3.54	2.89
Rated Speed		N _{rttd}	rpm	5200	8000	8000	3400	7300	8000	1600	3600	6600
Rated Power (speed) ②③		P _{rttd}	kW	0.095	0.135	0.135	0.094	0.170	0.180	0.075	0.151	0.225
			Hp	0.128	0.181	0.181	0.126	0.228	0.241	0.100	0.202	0.302
48 Vdc@155°C												
Rated Torque (speed) ①③		T _{rttd}	Nm	0.26	0.24	0.24	0.36	0.33	0.32	0.62	0.58	0.53
			lb-in	2.26	2.17	2.16	3.22	2.93	2.87	5.44	5.14	4.65
Rated Speed		N _{rttd}	rpm	4900	8000	8000	3100	7200	8000	1400	3500	6600
Rated Power (speed) ①③		P _{rttd}	kW	0.131	0.205	0.205	0.118	0.249	0.271	0.090	0.213	0.363
			Hp	0.176	0.275	0.274	0.159	0.334	0.364	0.121	0.286	0.487

- ① Motor winding at temp. rise, ΔT = 130°C, at 25°C ambient
- ② Motor winding at temp. rise, ΔT = 60°C, at 25°C ambient
- ③ All data referenced to sinusoidal commutation
- ④ May be limited at some values of V_{bus}
- ⑤ Measured at 25°C (without leads)
- ⑥ All values measured without leads
- ⑦ Estimated value
- ⑧ With housing and heat sink



TBM2G 50 Series Motor Parameters

Parameter	Tol	Symbol	Units	TBM2G-05008			TBM2G-05013			TBM2G-05026		
				A	C	D	A	C	D	A	C	D
Hot Torque Constant ①⑥⑧	+/- 10%	K _t	Nm/Arms	0.081	0.040	0.023	0.122	0.061	0.035	0.241	0.121	0.070
			lb-in/Arms	0.72	0.36	0.21	1.08	0.54	0.31	2.13	1.07	0.62
Cold Torque Constant ⑤⑨	+/- 10%	K _t	Nm/Arms	0.090	0.045	0.026	0.136	0.068	0.039	0.270	0.135	0.078
			lb-in/Arms	0.80	0.40	0.23	1.21	0.60	0.35	2.39	1.19	0.69
Hot Back EMF Constant ①⑥⑧	+/- 10%	K _e	Vrms/krpm	4.89	2.45	1.41	7.36	3.68	2.12	14.6	7.29	4.21
Cold Back EMF Constant ⑤⑧	+/- 10%	K _e	Vrms/krpm	5.44	2.72	1.57	8.24	4.12	2.38	16.3	8.16	4.71
Motor Constant ⑤	Nom	K _m	Nm/√W	0.061	0.061	0.061	0.083	0.082	0.082	0.128	0.128	0.128
			lb-in/√W	0.54	0.54	0.54	0.74	0.73	0.73	1.13	1.13	1.13
Resistance (line-line) ⑤⑧	+/- 10%	R _m	Ω	1.47	0.37	0.12	1.78	0.46	0.15	2.97	0.74	0.25
Inductance Q-Axis (line-line) ⑥⑧	+/- 20%	L _{qll}	mH	0.86	0.22	0.07	1.24	0.31	0.10	2.38	0.59	0.20

Parameter	Symbol	Unit	05008	05013	05026
			Value		
Inertia ①	J _m	kg-cm ²	0.079	0.104	0.176
		lb-in-s ²	6.99E-05	9.20E-05	1.56E-04
Weight ⑦	W	kg	0.111	0.149	0.260
		lb	0.245	0.328	0.573
Thermal Resistance	R _{thw-a}	°C/W	3.60	3.40	2.90
Pole Pairs	PP		7	7	7
Heatsink Size	4" x 3.75" x 0.25" Aluminum Plate				
Housing Geometry	Aluminum Housing [L x T]		1.26" x 0.25"	1.44" x 0.25"	1.97" x 0.25"

- ① Motor winding at temp. rise, $\delta T = 130^{\circ}\text{C}$, at 25°C ambient
- ② Motor winding at temp. rise, $\delta T = 60^{\circ}\text{C}$, at 25°C ambient
- ③ All data referenced to sinusoidal commutation
- ④ May be limited at some values of V_{bus}
- ⑤ Measured at 25°C (without leads)
- ⑥ All values measured without leads
- ⑦ Estimated value
- ⑧ With housing and heat sink

TBM2G 50 Series Motor

TBM2G 50 Series Performance Curves

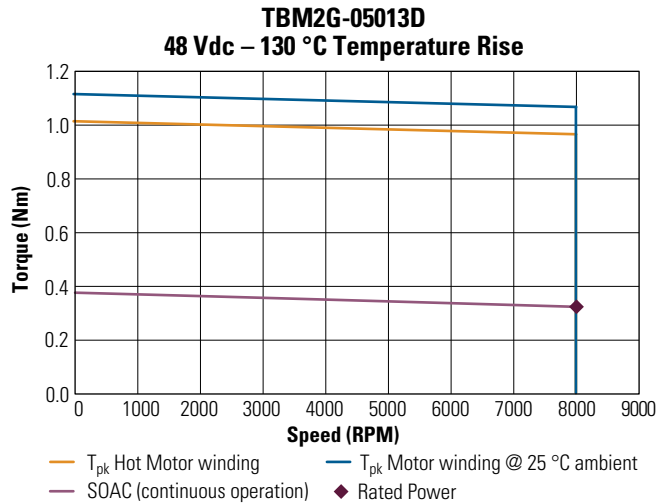
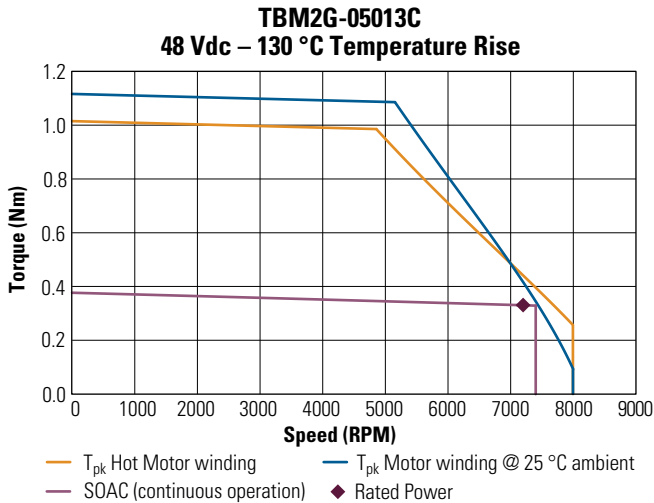
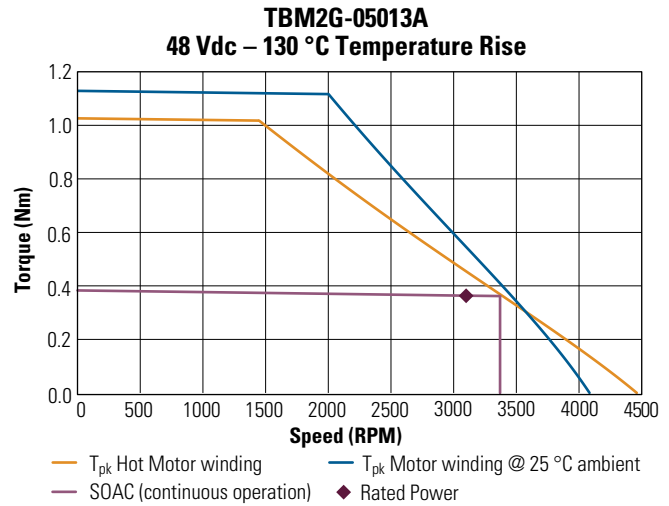
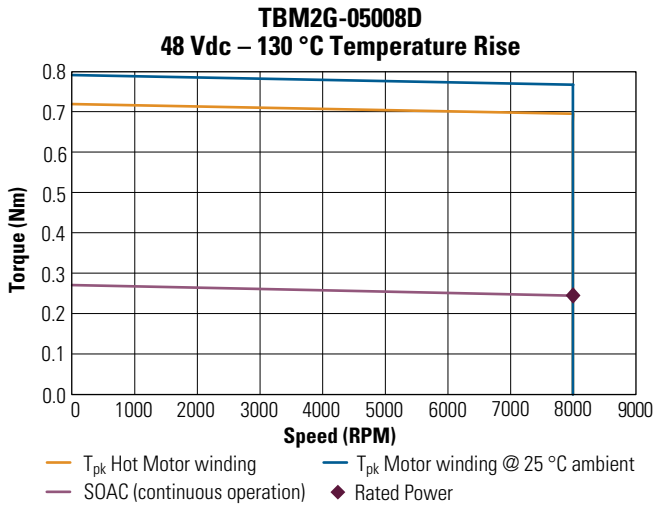
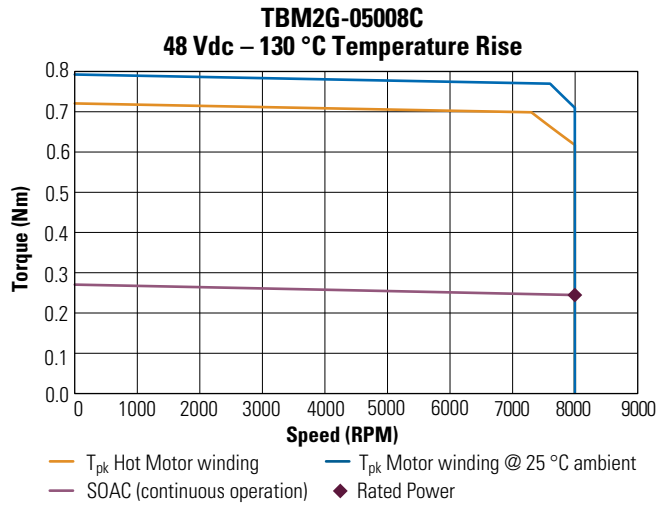
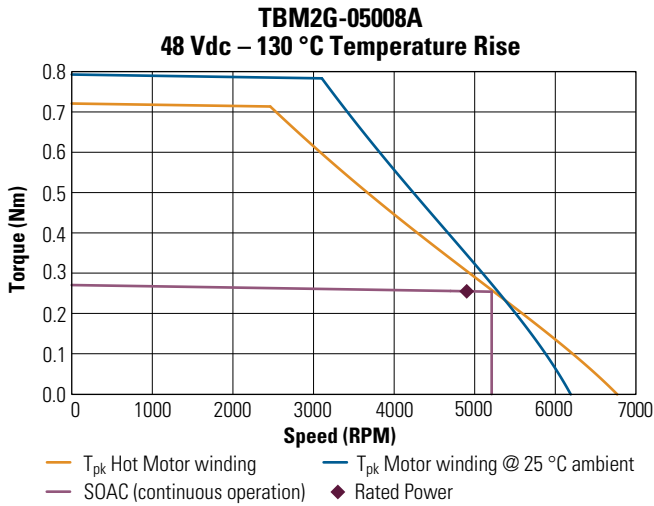

TBM2G 50 Series Performance Curves (Continued)

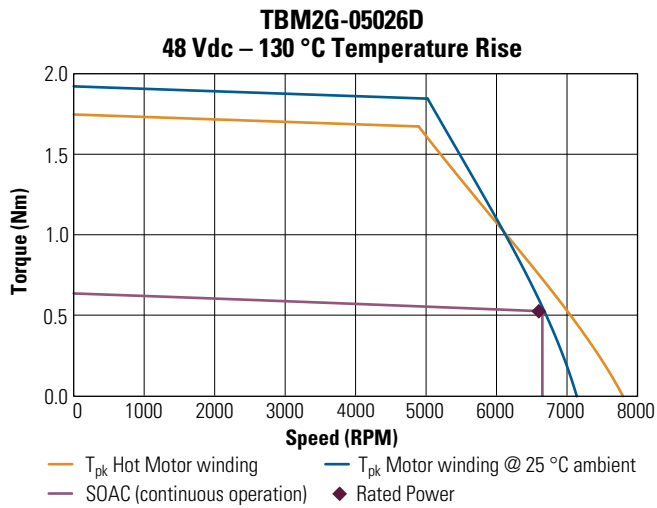
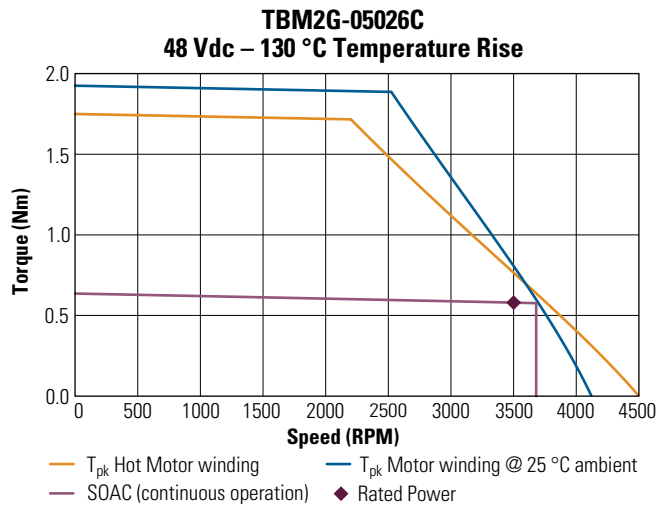
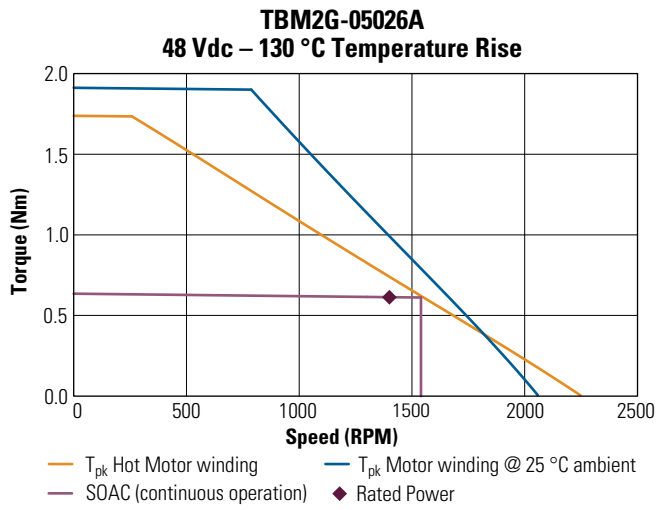

TBM2G 50 Series Motor

TBM2G 50 Series Dimensional Drawings

TBM2G-050

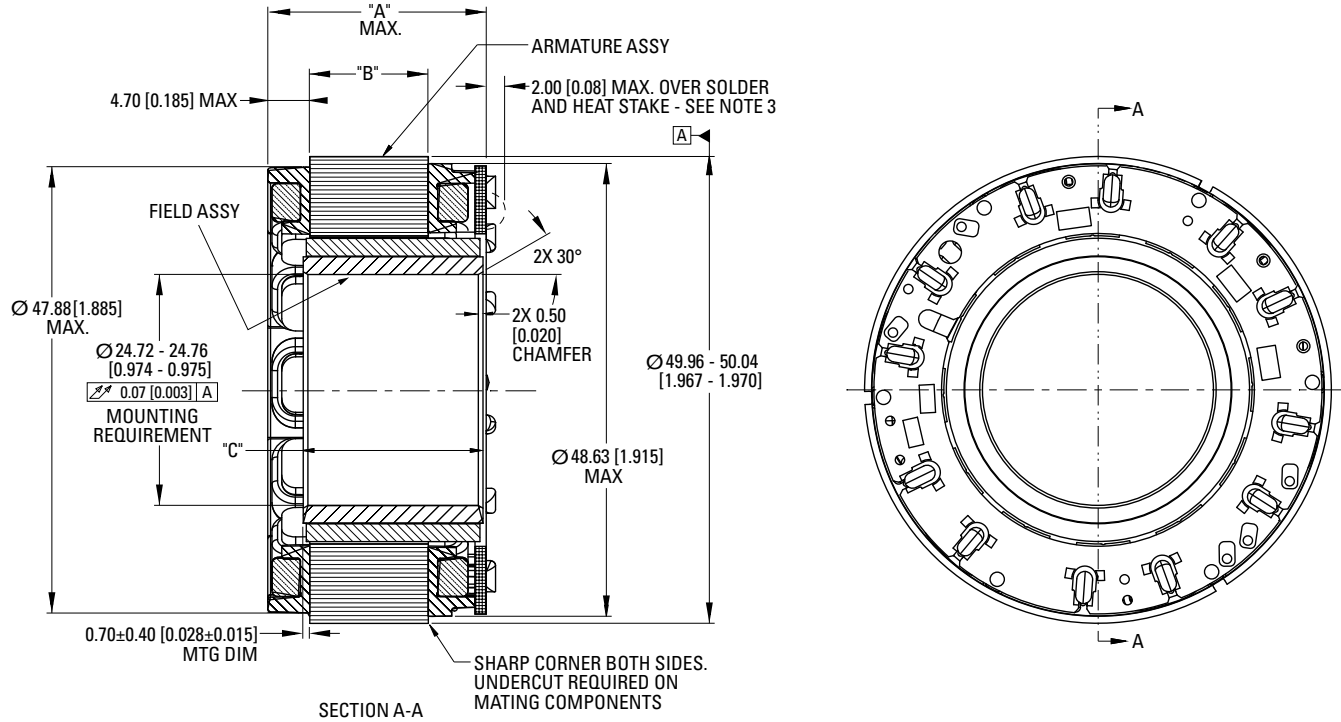

Stack Specific Dimensional Data

MODEL	"A" MAX.	"B" REF ±0.35 [0.014]	"C" ±0.08 [0.004]
TBM2G-05008	19.84 [0.781]	8.2 [0.323]	14.76 [0.581]
TBM2G-05013	24.34 [0.958]	12.70 [0.500]	19.26 [0.758]
TBM2G-05026	37.94 [1.494]	26.30 [1.035]	32.86 [1.294]

Notes:

1. All dimensions are in mm [inches] and are for reference only.
2. Motor supplied as two separate components: armature & sensor assembly and field assembly.
3. Customer must provide 0.25 [0.010] min. clearance from all solder and heat stakes.

TBM2G 50 Series Optional Lead Specifications

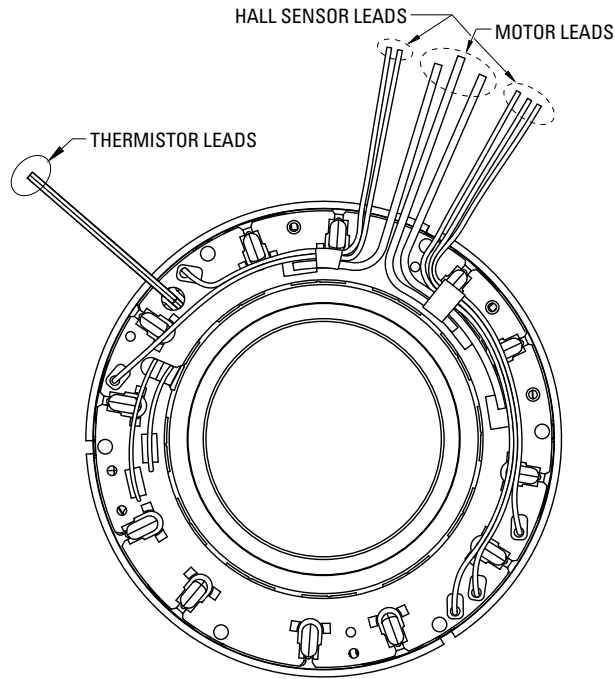

Motor Leads:

#20 AWG, ETFE Coated, Per UL Style 10086
 3 Leads, 0.5 m Length
 1 - Red, 1 - White, & 1 - Black
 Minimum Motor Lead Bend Radius 7.37 [0.290]

Hall Sensor Leads:

#26 AWG, ETFE Coated, Per UL Style 10086
 5 Leads, 0.5 m Length
 Minimum Lead Bend Radius 4.95 [0.195]

Thermistor Leads:

#26 AWG, ETFE Coated, Per UL Style 10086
 2 White Leads, 0.5 m Length
 Minimum Lead Bend Radius 4.95 [0.195]

Connection Options

PN Lead Designation	Lead Length (Min)
A	0.5 m
N	No leads

Sensor Options

PN Lead Designation	Lead Length (Min)
H	Hall Sensor
N	No Device

Thermal Device Options

PN Lead Designation	Lead Length (Min)
A	PT1000
B	3x PTC Devices
N	No Device

See Leads Connection Diagrams on page 52.

TBM2G 60 Series Motor

TBM2G 60 Series Performance Data

Parameter	Tol	Symbol	Units	TBM2G-06008			TBM2G-06013			TBM2G-06026		
				A	C	D	A	C	D	A	C	D
Rated Equivalent Line Voltage ⑥⑧		V _{bus}	Vdc	48	48	48	48	48	48	48	48	48
Max Cont. Torque for ΔT wdg. = 130°C ①④⑥⑧		T _{mc1}	Nm	0.45	0.45	0.45	0.60	0.60	0.60	0.96	0.96	0.96
			lb-in	3.97	3.97	3.97	5.30	5.30	5.30	8.54	8.54	8.54
Max Cont. Current for ΔT wdg. = 130°C ①④⑥⑧		I _{mc1}	Arms	3.73	7.46	12.9	3.38	6.75	11.7	2.72	5.45	9.43
Max Cont. Torque for ΔT wdg. = 60°C ②④⑥⑧		T _{mc2}	Nm	0.35	0.35	0.35	0.46	0.46	0.46	0.75	0.75	0.75
			lb-in	3.06	3.06	3.06	4.10	4.10	4.10	6.64	6.64	6.64
Max Cont. Current for ΔT wdg. = 60°C ②④⑥⑧		I _{mc2}	Arms	2.67	5.34	9.25	2.42	4.85	8.39	1.97	3.93	6.81
Max mechanical speed		N _{max}	rpm	8000	8000	8000	8000	8000	8000	8000	8000	8000
Peak Torque ①④		T _p	Nm	1.22	1.22	1.22	1.67	1.67	1.67	2.60	2.76	2.76
			lb-in	10.8	10.8	10.8	14.8	14.8	14.8	23.0	24.4	24.4
Peak Current ⑥⑧		I _p	Arms	11.1	22.3	38.6	10.1	20.2	35.0	7.7	16.3	28.2
24 Vdc@85°C												
Rated Torque (speed) ②③		T _{rttd}	Nm	0.33	0.31	0.28	0.44	0.42	0.39	0.74	0.71	0.67
			lb-in	2.91	2.71	2.49	3.94	3.71	3.43	6.53	6.24	5.90
Rated Speed		N _{rttd}	rpm	1400	3400	6300	900	2200	4200	300	1000	2000
Rated Power (speed) ②③		P _{rttd}	kW	0.048	0.109	0.185	0.042	0.097	0.171	0.023	0.074	0.140
			Hp	0.065	0.146	0.249	0.056	0.130	0.229	0.031	0.099	0.187
24 Vdc@155°C												
Rated Torque (speed) ①③		T _{rttd}	Nm	0.44	0.43	0.41	0.59	0.58	0.56	0.96	0.94	0.92
			lb-in	3.92	3.79	3.64	5.25	5.11	4.92	8.52	8.36	8.12
Rated Speed		N _{rttd}	rpm	1000	3100	6000	600	2000	4000	100	900	1900
Rated Power (speed) ①③		P _{rttd}	kW	0.046	0.139	0.258	0.037	0.121	0.223	0.010	0.089	0.183
			Hp	0.062	0.187	0.347	0.050	0.162	0.312	0.014	0.119	0.245
48 Vdc@85°C												
Rated Torque (speed) ②③		T _{rttd}	Nm	0.28	0.22	0.25	0.39	0.31	0.27	0.69	0.59	0.48
			lb-in	2.51	1.92	2.23	3.47	2.74	2.43	6.09	5.19	4.21
Rated Speed		N _{rttd}	rpm	3400	7500	8000	2300	5100	8000	1000	2400	4500
Rated Power (speed) ②③		P _{rttd}	kW	0.101	0.171	0.211	0.094	0.165	0.230	0.072	0.147	0.224
			Hp	0.135	0.229	0.283	0.126	0.221	0.309	0.097	0.198	0.301
48 Vdc@155°C												
Rated Torque (speed) ①③		T _{rttd}	Nm	0.42	0.39	0.39	0.57	0.53	0.50	0.94	0.89	0.82
			lb-in	3.73	3.41	3.48	5.03	4.65	4.38	8.32	7.84	7.30
Rated Speed		N _{rttd}	rpm	3100	7200	8000	2000	4800	8000	900	2300	4400
Rated Power (speed) ①③		P _{rttd}	kW	0.137	0.291	0.329	0.119	0.264	0.415	0.089	0.213	0.380
			Hp	0.183	0.390	0.442	0.160	0.355	0.556	0.119	0.286	0.510

- ① Motor winding at temp. rise, ΔT = 130°C, at 25°C ambient
- ② Motor winding at temp. rise, ΔT = 60°C, at 25°C ambient
- ③ All data referenced to sinusoidal commutation
- ④ May be limited at some values of V_{bus}
- ⑤ Measured at 25°C (without leads)
- ⑥ All values measured without leads
- ⑦ Estimated value
- ⑧ With housing and heat sink

TBM2G 60 Series Motor Parameters

Parameter	Tol	Symbol	Units	TBM2G-06008			TBM2G-06013			TBM2G-06026		
				A	C	D	A	C	D	A	C	D
Hot Torque Constant ①⑥⑧	+/- 10%	K_t	Nm/Arms	0.121	0.061	0.035	0.177	0.089	0.051	0.354	0.177	0.102
			lb-in/Arms	1.07	0.54	0.31	1.57	0.78	0.45	3.13	1.57	0.90
Cold Torque Constant ⑤⑨	+/- 10%	K_t	Nm/Arms	0.135	0.067	0.039	0.199	0.099	0.057	0.397	0.198	0.114
			lb-in/Arms	1.19	0.60	0.34	1.76	0.88	0.51	3.51	1.75	1.01
Hot Back EMF Constant ①⑥⑧	+/- 10%	K_e	Vrms/krpm	7.33	3.66	2.11	10.72	5.36	3.09	21.4	10.7	6.18
Cold Back EMF Constant ⑤⑧	+/- 10%	K_e	Vrms/krpm	8.15	4.07	2.35	12.0	6.00	3.47	24.0	12.0	6.9
Motor Constant ⑤	Nom	K_m	Nm/ \sqrt{W}	0.087	0.087	0.087	0.114	0.114	0.114	0.176	0.176	0.176
			lb-in/ \sqrt{W}	0.77	0.77	0.077	1.01	1.01	1.01	1.56	1.56	1.56
Resistance (line-line) ⑤⑧	+/- 10%	R_m	Ω	1.60	0.400	0.133	2.01	0.503	0.168	3.39	0.847	0.282
Inductance Q-Axis (line-line) ⑥⑧	+/- 20%	L_{qll}	mH	1.06	0.27	0.09	1.55	0.39	0.13	3.03	0.76	0.25

Parameter	Symbol	Unit	06008	06013	06026
			Value		
Inertia ①	J_m	kg-cm ²	0.137	0.147	0.308
		lb-in-s ²	1.21E-04	1.30E-04	2.73E-04
Weight ⑦	W	kg	0.139	0.195	0.351
		lb	0.306	0.430	0.774
Thermal Resistance	R_{thw-a}	$^{\circ}C/W$	2.60	2.52	2.30
Pole Pairs	PP		10	10	10
Heatsink Size	5" x 5" x 0.25" Aluminum Plate				
Housing Geometry	Aluminum Housing [L x T]		1.15" x 0.25"	1.33" x 0.25"	1.86" x 0.25"

- ① Motor winding at temp. rise, $\delta T = 130^{\circ}C$, at $25^{\circ}C$ ambient
- ② Motor winding at temp. rise, $\delta T = 60^{\circ}C$, at $25^{\circ}C$ ambient
- ③ All data referenced to sinusoidal commutation
- ④ May be limited at some values of V_{bus}
- ⑤ Measured at $25^{\circ}C$ (without leads)
- ⑥ All values measured without leads
- ⑦ Estimated value
- ⑧ With housing and heat sink

TBM2G 60 Series Motor

TBM2G 60 Series Performance Curves

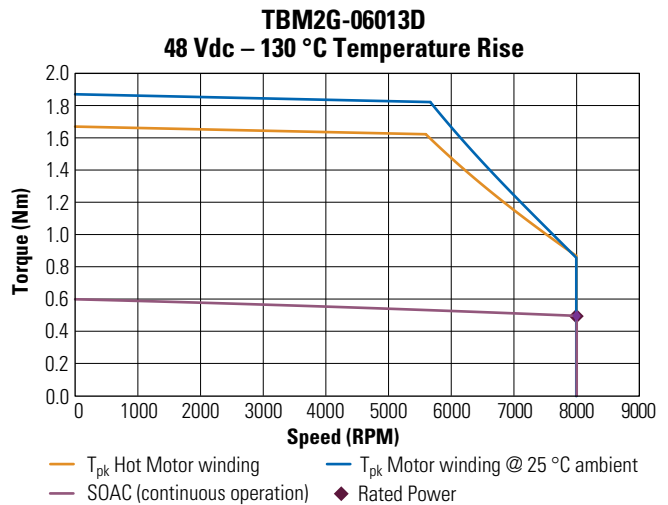
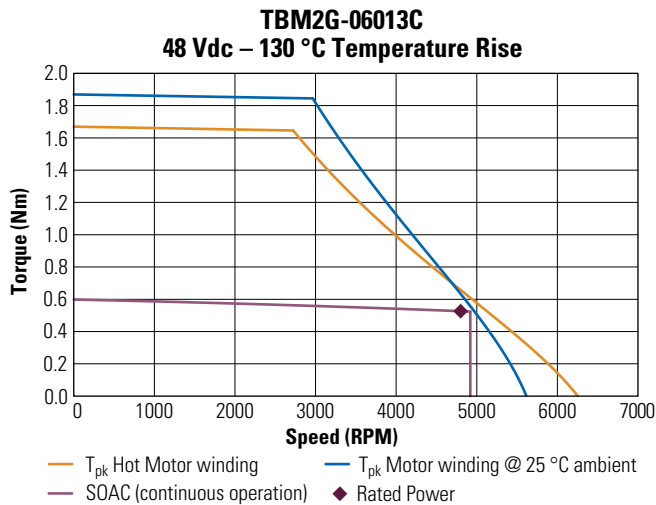
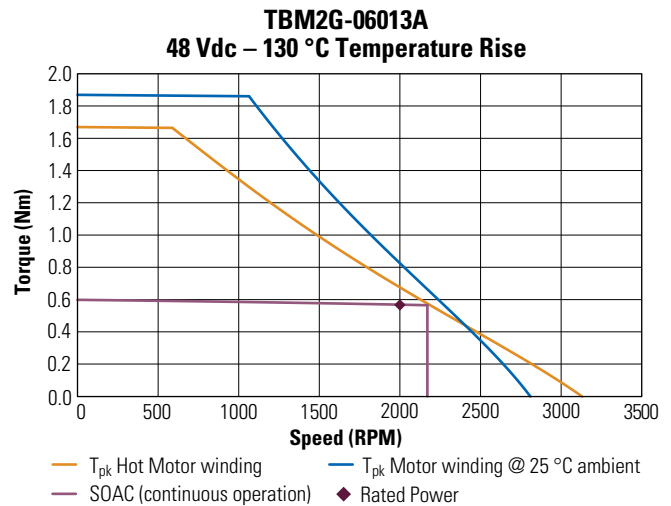
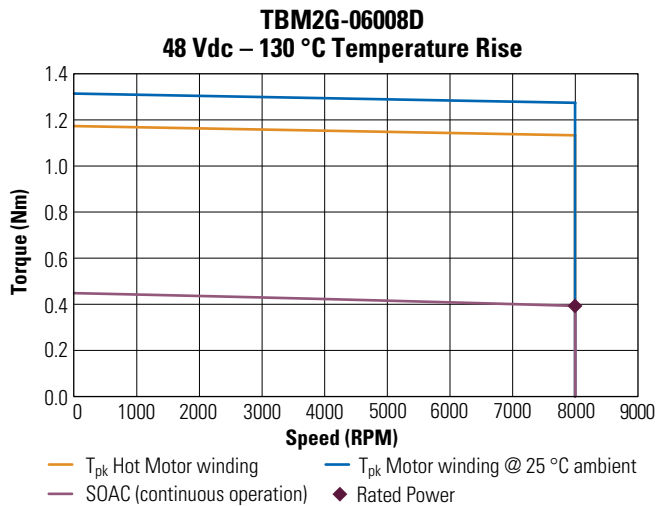
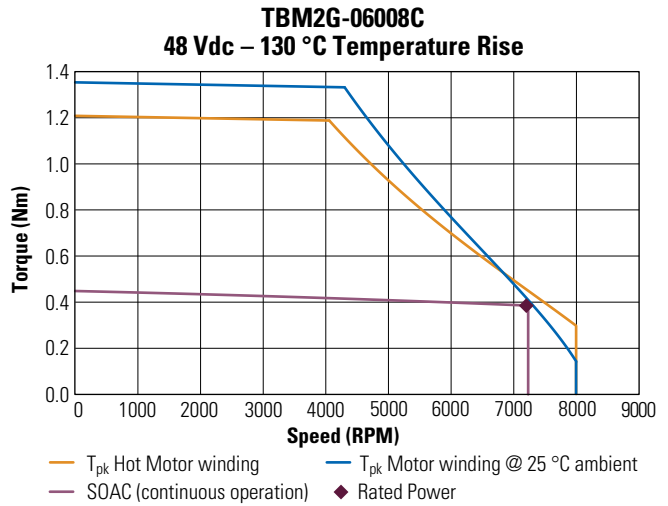
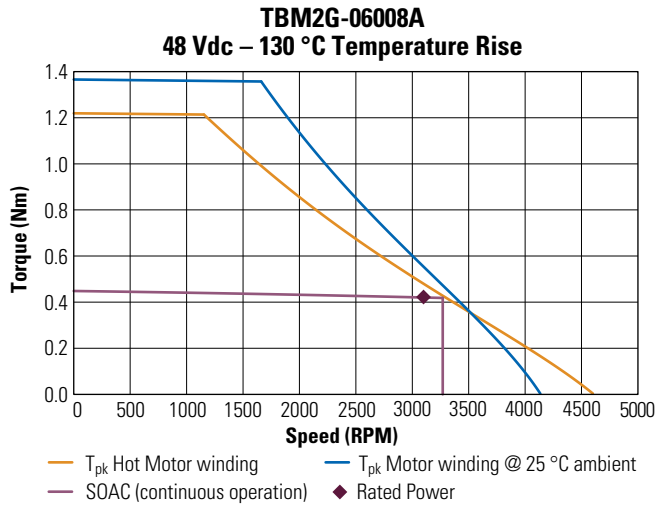

TBM2G 60 Series Performance Curves (Continued)

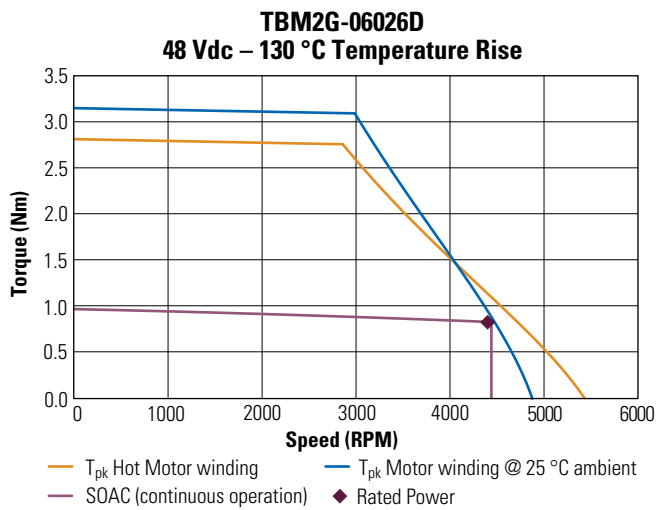
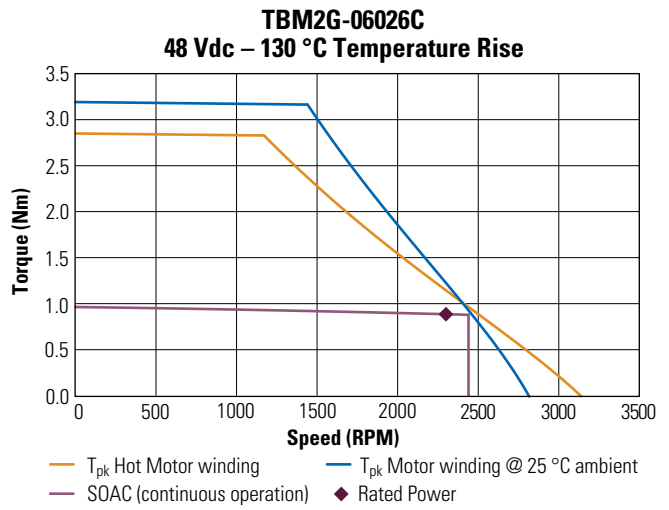
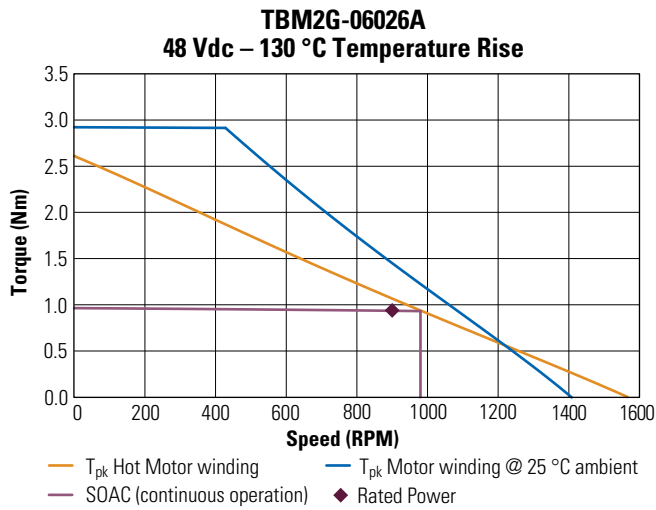

TBM2G 60 Series Motor

TBM2G 60 Series Dimensional Drawings

TBM2G-060

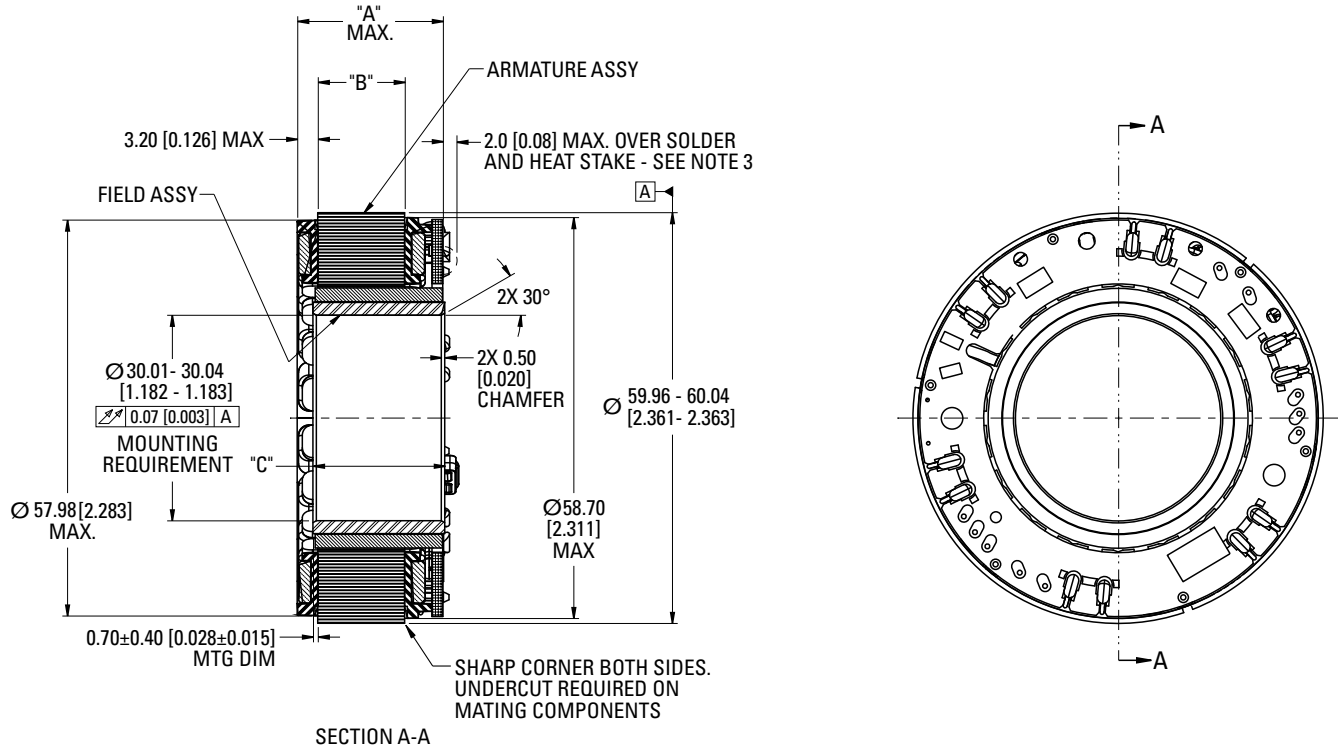

Stack Specific Dimensional Data

MODEL	"A" MAX.	"B" REF ±0.35 [0.014]	"C" ±0.08 [0.004]
TBM2G-06008	17.71 [0.697]	8.2 [0.323]	14.76 [0.581]
TBM2G-06013	22.21 [0.874]	12.70 [0.500]	19.26 [0.758]
TBM2G-06026	35.81 [1.410]	26.30 [1.035]	32.86 [1.294]

Notes:

1. All dimensions are in mm [inches] and are for reference only.
2. Motor supplied as two separate components: armature & sensor assembly and field assembly.
3. Customer must provide 0.25 [0.010] min. clearance from all solder and heat stakes.

TBM2G 60 Series Optional Lead Specifications

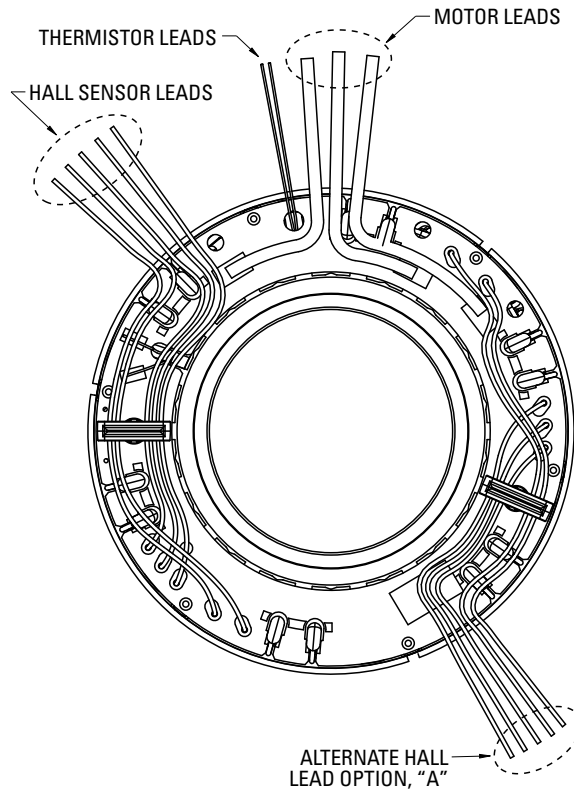

Motor Leads:

#20 AWG, ETFE Coated, Per UL Style 10086
 3 Leads, 0.5 m Length
 1 - Red, 1 - White, & 1 - Black
 Minimum Motor Lead Bend Radius 7.37 [0.290]

Hall Sensor Leads:

#26 AWG, ETFE Coated, Per UL Style 10086
 5 Leads, 0.5 m Length
 Minimum Lead Bend Radius 4.95 [0.195]

Thermistor Leads:

#26 AWG, ETFE Coated, Per UL Style 10086
 2 White Leads, 0.5 m Length
 Minimum Lead Bend Radius 4.95 [0.195]

Connection Options

PN Lead Designation	Lead Length (Min)
A	0.5 m
N	No leads

Sensor Options

PN Lead Designation	Lead Length (Min)
A	Hall Sensor Alternate Location
H	Hall Sensor
N	No Device

Thermal Device Options

PN Lead Designation	Lead Length (Min)
A	PT1000
B	3x PTC Devices
N	No Device

See Leads Connection Diagrams on page 52.

TBM2G 68 Series Motor

TBM2G 68 Series Performance Data

Parameter	Tol	Symbol	Units	TBM2G-06808			TBM2G-06813			TBM2G-06826		
				A	C	D	A	C	D	A	C	D
Rated Equivalent Line Voltage ⑥⑧		V _{bus}	Vdc	48	48	48	48	48	48	48	48	48
Max Cont. Torque for ΔT wdg. = 130°C ①④⑥⑧		T _{mc1}	Nm	0.63	0.63	0.63	0.85	0.86	0.86	1.54	1.54	1.54
			lb-in	5.58	5.60	5.60	7.48	7.64	7.64	13.6	13.6	13.6
Max Cont. Current for ΔT wdg. = 130°C ①④⑥⑧		I _{mc1}	Arms	4.14	8.27	14.3	3.76	7.67	13.3	3.48	6.96	12.1
Max Cont. Torque for ΔT wdg. = 60°C ②④⑥⑧		T _{mc2}	Nm	0.50	0.50	0.50	0.66	0.67	0.67	1.19	1.19	1.19
			lb-in	4.39	4.39	4.39	5.82	5.94	5.93	10.6	10.6	10.6
Max Cont. Current for ΔT wdg. = 60°C ②④⑥⑧		I _{mc2}	Arms	3.01	6.02	10.4	2.71	5.54	9.60	2.50	5.01	8.68
Max mechanical speed		N _{max}	rpm	8000	8000	8000	8000	8000	8000	8000	8000	8000
Peak Torque ①④		T _p	Nm	1.54	1.53	1.53	2.14	2.19	2.19	3.96	4.12	4.13
			lb-in	13.6	13.5	13.5	19.0	19.4	19.4	35.1	36.4	36.5
Peak Current ⑥⑧		I _p	Arms	12.4	24.7	42.8	11.2	22.9	39.7	10.0	20.8	36.1
24 Vdc@85°C												
Rated Torque (speed) ②③		T _{rttd}	Nm	0.48	0.46	0.43	0.66	0.64	0.61	1.19	1.17	1.14
			lb-in	4.27	4.09	3.83	5.84	5.68	5.42	10.5	10.3	10.1
Rated Speed		N _{rttd}	rpm	1100	2600	4900	700	1600	3300	300	800	1600
Rated Power (speed) ②③		P _{rttd}	kW	0.056	0.126	0.222	0.147	0.108	0.212	0.037	0.098	0.191
			Hp	0.074	0.169	0.298	0.064	0.144	0.284	0.050	0.131	0.256
24 Vdc@155°C												
Rated Torque (speed) ①③		T _{rttd}	Nm	0.63	0.61	0.59	0.84	0.85	0.83	1.54	1.53	1.51
			lb-in	5.55	5.42	5.26	7.45	7.49	7.32	13.6	13.5	13.4
Rated Speed		N _{rttd}	rpm	800	2400	4700	500	1600	3200	100	700	1500
Rated Power (speed) ①③		P _{rttd}	kW	0.053	0.154	0.292	0.044	0.142	0.277	0.016	0.112	0.237
			Hp	0.070	0.207	0.392	0.059	0.190	0.372	0.022	0.150	0.318
48 Vdc@85°C												
Rated Torque (speed) ②③		T _{rttd}	Nm	0.46	0.41	0.39	0.62	0.59	0.53	1.16	1.12	1.07
			lb-in	4.02	3.62	3.41	5.48	5.22	4.73	10.3	9.9	9.4
Rated Speed		N _{rttd}	rpm	2600	5700	8000	1700	3900	7000	800	1900	3500
Rated Power (speed) ②③		P _{rttd}	kW	0.124	0.244	0.323	0.110	0.241	0.392	0.097	0.223	0.391
			Hp	0.166	0.327	0.433	0.148	0.323	0.526	0.130	0.300	0.524
48 Vdc@155°C												
Rated Torque (speed) ①③		T _{rttd}	Nm	0.61	0.58	0.56	0.83	0.81	0.78	1.53	1.50	1.46
			lb-in	5.41	5.13	4.94	7.32	7.20	6.87	13.5	13.3	12.9
Rated Speed		N _{rttd}	rpm	2400	5500	8000	1600	3700	6900	700	1800	3400
Rated Power (speed) ①③		P _{rttd}	kW	0.154	0.334	0.468	0.139	0.315	0.561	0.112	0.283	0.521
			Hp	0.206	0.448	0.627	0.186	0.422	0.753	0.150	0.380	0.699

- ① Motor winding at temp. rise, ΔT = 130°C, at 25°C ambient
- ② Motor winding at temp. rise, ΔT = 60°C, at 25°C ambient
- ③ All data referenced to sinusoidal commutation
- ④ May be limited at some values of V_{bus}
- ⑤ Measured at 25°C (without leads)
- ⑥ All values measured without leads
- ⑦ Estimated value
- ⑧ With housing and heat sink



TBM2G 68 Series Motor Parameters

Parameter	Tol	Symbol	Units	TBM2G-06808			TBM2G-06813			TBM2G-06826		
				A	C	D	A	C	D	A	C	D
Hot Torque Constant ①⑥⑧	+/- 10%	K_t	Nm/Arms	0.153	0.076	0.044	0.225	0.113	0.065	0.442	0.221	0.128
			lb-in/Arms	1.35	0.68	0.39	1.99	1.00	0.57	3.92	1.96	1.13
Cold Torque Constant ⑤⑧	+/- 10%	K_t	Nm/Arms	0.171	0.086	0.049	0.252	0.126	0.073	0.496	0.248	0.143
			lb-in/Arms	1.52	0.76	0.44	2.23	1.12	0.64	4.39	2.19	1.27
Hot Back EMF Constant ①⑥⑧	+/- 10%	K_e	Vrms/krpm	9.24	4.62	2.67	13.6	6.80	3.93	26.7	13.4	7.72
Cold Back EMF Constant ⑤⑧	+/- 10%	K_e	Vrms/krpm	10.4	5.18	2.99	15.2	7.62	4.40	30.0	15.0	8.65
Motor Constant ⑤	Nom	K_m	Nm/ \sqrt{W}	0.119	0.119	0.119	0.154	0.157	0.157	0.251	0.251	0.251
			lb-in/ \sqrt{W}	1.05	1.05	1.05	1.37	1.39	1.39	2.22	2.22	2.22
Resistance (line-line) ⑤⑧	+/- 10%	R_m	Ω	1.38	0.345	0.115	1.78	0.427	0.142	2.60	0.651	0.217
Inductance Q-Axis (line-line) ⑥⑧	+/- 20%	L_{qll}	mH	1.26	0.32	0.11	1.82	0.46	0.15	3.51	0.88	0.29

Parameter	Symbol	Unit	06808	06813	06826
			Value		
Inertia ①	J_m	kg-cm ²	0.239	0.309	0.518
		lb-in-s ²	2.12E-04	2.73E-04	4.58E-04
Weight ⑦	W	kg	0.188	0.254	0.462
		lb	0.414	0.560	1.019
Thermal Resistance	R_{thw-a}	$^{\circ}C/W$	2.45	2.30	1.83
Pole Pairs	PP		10	10	10
Heatsink Size	7.5" x 7" x 0.375" Aluminum Plate				
Housing Geometry	Aluminum Housing [L x T]		1.36" x 0.25"	1.53" x 0.25"	2.06" x 0.25"

- ① Motor winding at temp. rise, $\delta T = 130^{\circ}C$, at $25^{\circ}C$ ambient
- ② Motor winding at temp. rise, $\delta T = 60^{\circ}C$, at $25^{\circ}C$ ambient
- ③ All data referenced to sinusoidal commutation
- ④ May be limited at some values of V_{bus}
- ⑤ Measured at $25^{\circ}C$ (without leads)
- ⑥ All values measured without leads
- ⑦ Estimated value
- ⑧ With housing and heat sink

TBM2G 68 Series Motor

TBM2G 68 Series Performance Curves

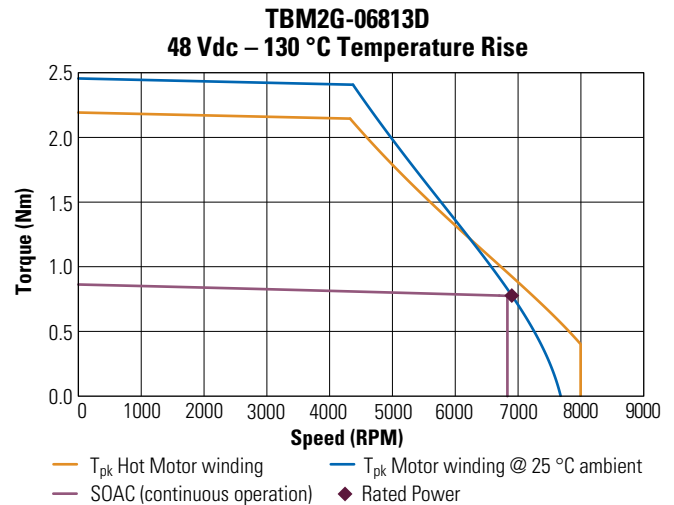
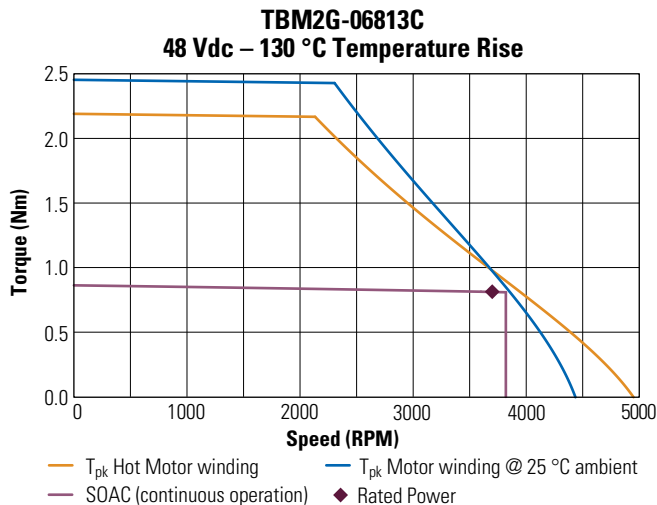
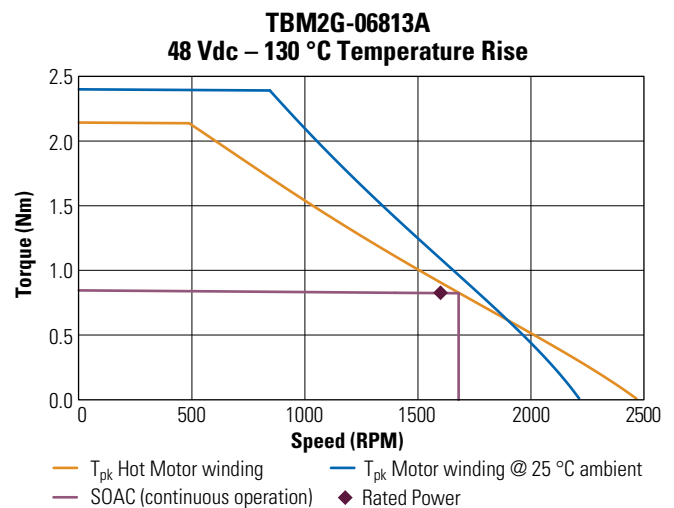
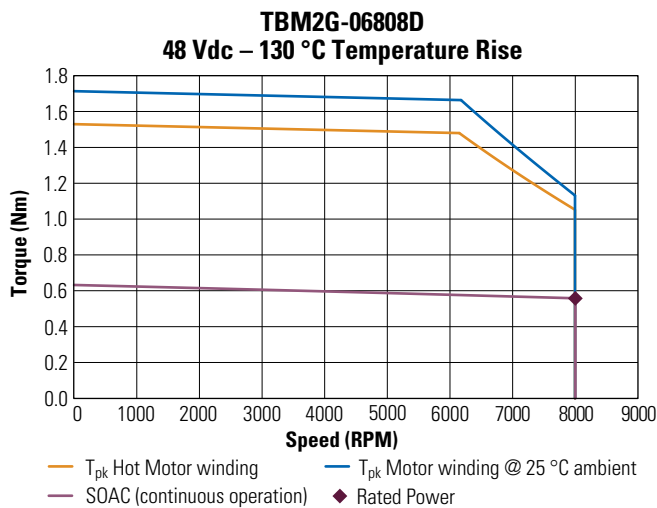
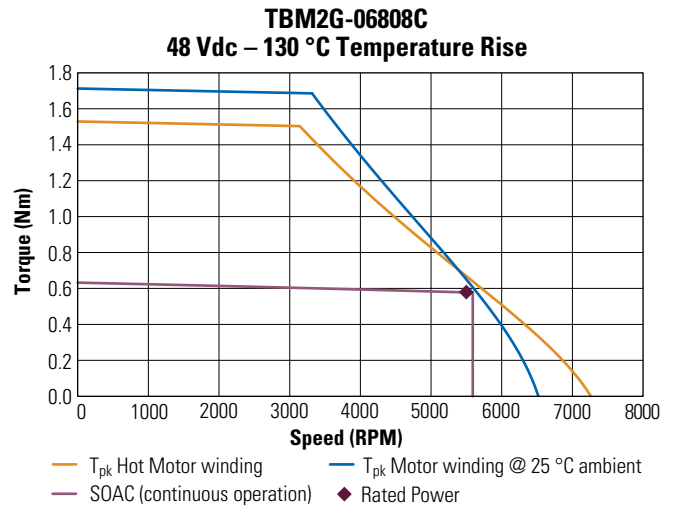
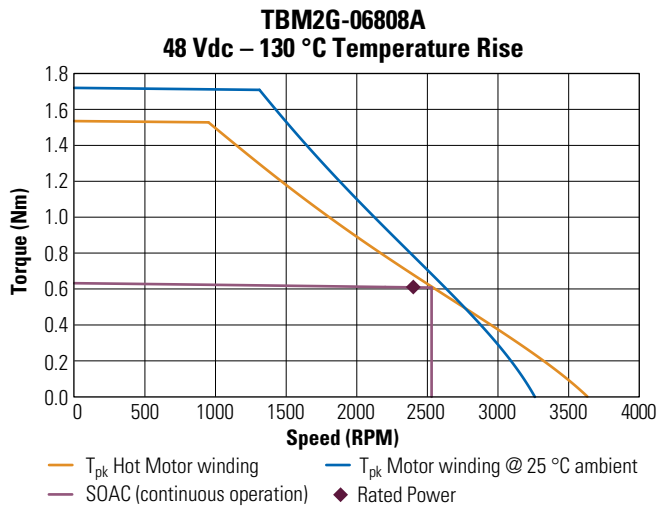

TBM2G 68 Series Performance Curves (Continued)

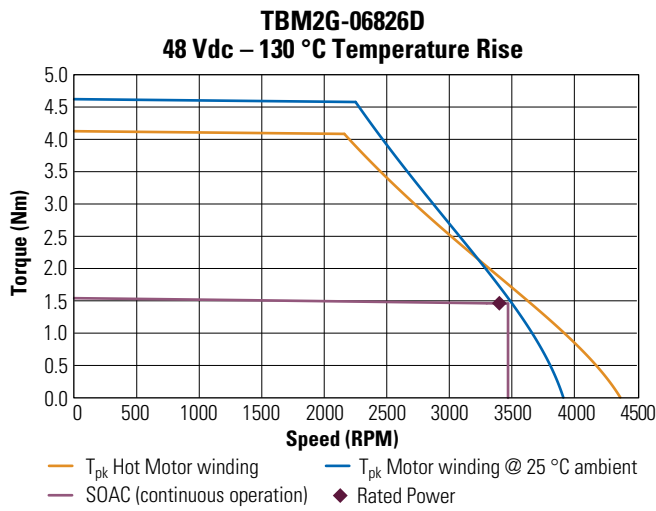
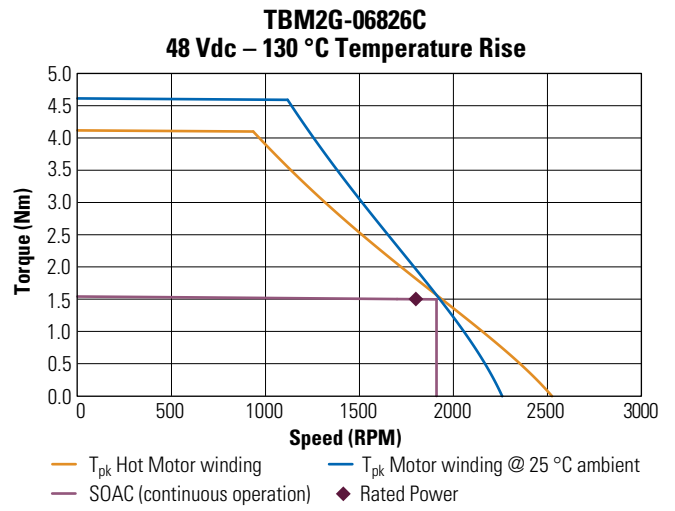
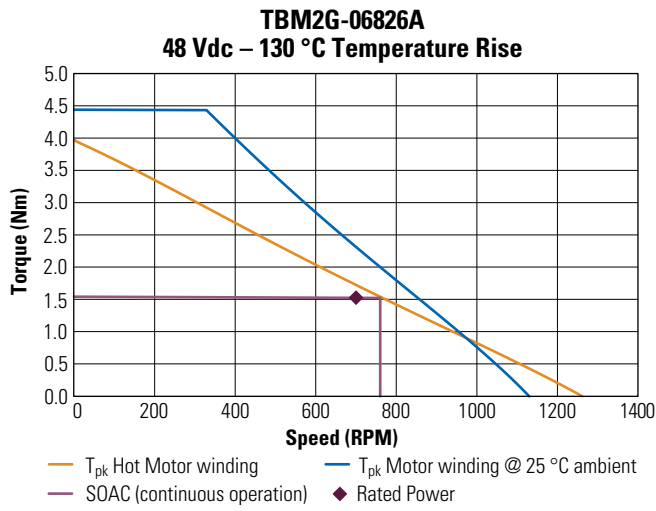

TBM2G 68 Series Motor

TBM2G 68 Series Dimensional Drawings

TBM2G-068

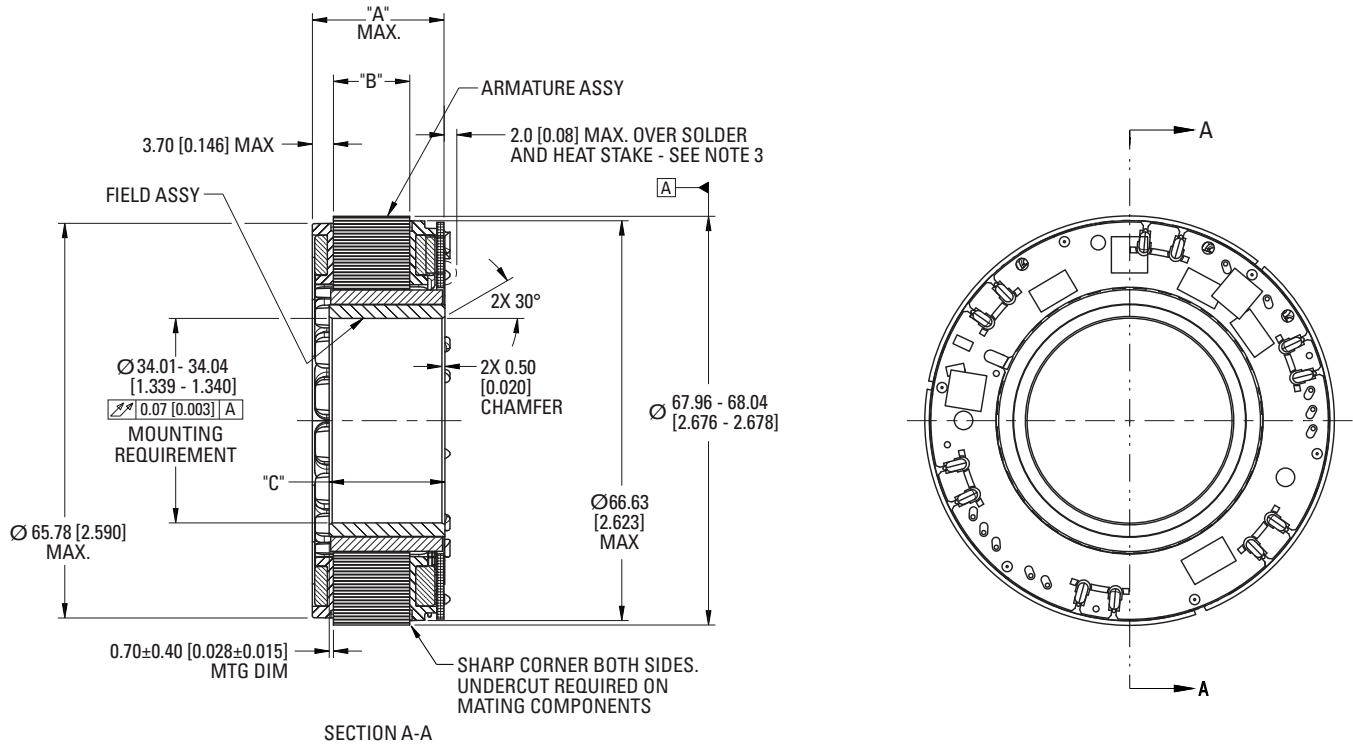

Stack Specific Dimensional Data

MODEL	"A" MAX.	"B" REF ±0.35 [0.014]	"C" ±0.08 [0.004]
TBM2G-06808	18.34 [0.722]	8.2 [0.323]	14.76 [0.581]
TBM2G-06813	22.84 [0.899]	12.70 [0.500]	19.26 [0.758]
TBM2G-06826	36.44 [1.435]	26.30 [1.035]	32.86 [1.294]

Notes:

1. All dimensions are in mm [inches] and are for reference only.
2. Motor supplied as two separate components: armature & sensor assembly and field assembly.
3. Customer must provide 0.25 [0.010] min. clearance from all solder and heat stakes.

TBM2G 68 Series Optional Lead Specifications

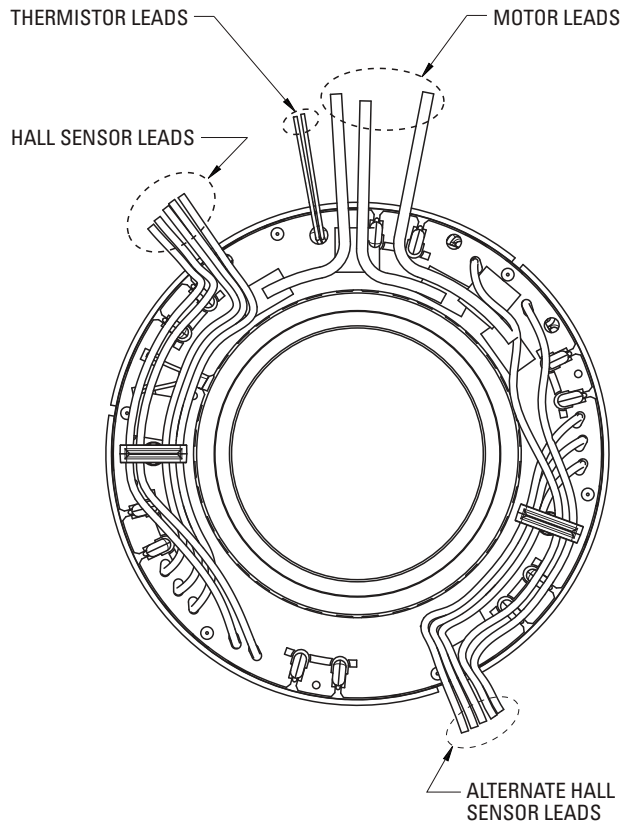

Motor Leads:

#20 AWG, ETFE Coated, Per UL Style 10086
 3 Leads, 0.5 m Length
 1 - Red, 1 - White, & 1 - Black
 Minimum Motor Lead Bend Radius 7.37 [0.290]

Hall Sensor Leads:

#26 AWG, ETFE Coated, Per UL Style 10086
 5 Leads, 0.5 m Length
 Minimum Lead Bend Radius 4.95 [0.195]

Thermistor Leads:

#26 AWG, ETFE Coated, Per UL Style 10086
 2 White Leads, 0.5 m Length
 Minimum Lead Bend Radius 4.95 [0.195]

Connection Options

PN Lead Designation	Lead Length (Min)
A	0.5 m
N	No leads

Sensor Options

PN Lead Designation	Lead Length (Min)
A	Hall Sensor Alternate Location
H	Hall Sensor
N	No Device

Thermal Device Options

PN Lead Designation	Lead Length (Min)
A	PT1000
B	3x PTC Devices
N	No Device

See Leads Connection Diagrams on page 52.

TBM2G 76 Series Motor

TBM2G 76 Series Performance Data

Parameter	Tol	Symbol	Units	TBM2G-07608			TBM2G-07613			TBM2G-07626		
				A	C	D	A	C	D	A	C	D
Rated Equivalent Line Voltage ⑥⑧		V _{bus}	Vdc	48	48	48	48	48	48	48	48	48
Max Cont. Torque for ΔT wdg. = 130°C ①④⑥⑧		T _{mc1}	Nm	0.89	0.89	0.89	1.23	1.23	1.23	2.06	2.06	2.06
			lb-in	7.85	7.85	7.88	10.9	10.9	10.9	18.2	18.2	18.2
Max Cont. Current for ΔT wdg. = 130°C ①④⑥⑧		I _{mc1}	Arms	4.60	9.19	15.9	4.37	8.74	15.1	3.82	7.64	13.2
Max Cont. Torque for ΔT wdg. = 60°C ②④⑥⑧		T _{mc2}	Nm	0.70	0.70	0.70	0.93	0.93	0.93	1.60	1.60	1.60
			lb-in	6.20	6.20	6.20	8.25	8.25	8.25	14.2	14.2	14.2
Max Cont. Current for ΔT wdg. = 60°C ②④⑥⑧		I _{mc2}	Arms	3.37	6.74	11.7	3.08	6.15	10.7	2.75	5.51	9.54
Max mechanical speed		N _{max}	rpm	8000	8000	8000	8000	8000	8000	8000	8000	8000
Peak Torque ①④		T _p	Nm	2.23	2.23	2.23	3.42	3.42	3.42	5.56	5.66	5.67
			lb-in	19.7	19.7	19.7	30.3	30.3	30.3	49.2	50.1	50.2
Peak Current ⑥⑧		I _p	Arms	13.7	27.5	47.6	13.1	26.1	45.2	11.2	22.8	39.6
24 Vdc@85°C												
Rated Torque (speed) ②③		T _{rttd}	Nm	0.68	0.65	0.59	0.92	0.88	0.82	1.59	1.55	1.48
			lb-in	6.06	5.78	5.21	8.11	7.82	7.22	14.0	13.7	13.1
Rated Speed		N _{rttd}	rpm	800	2000	3900	500	1300	2600	200	600	1300
Rated Power (speed) ②③		P _{rttd}	kW	0.057	0.137	0.240	0.048	0.120	0.222	0.033	0.098	0.202
			Hp	0.077	0.183	0.322	0.064	0.161	0.298	0.045	0.131	0.270
24 Vdc@155°C												
Rated Torque (speed) ①③		T _{rttd}	Nm	0.88	0.86	0.82	1.23	1.20	1.16	2.06	2.04	1.99
			lb-in	7.79	7.60	7.25	10.85	10.65	10.27	18.2	18.0	17.6
Rated Speed		N _{rttd}	rpm	600	1900	3800	300	1200	2500	100	500	1200
Rated Power (speed) ①③		P _{rttd}	kW	0.055	0.171	0.326	0.039	0.151	0.304	0.022	0.107	0.250
			Hp	0.074	0.229	0.437	0.052	0.203	0.407	0.029	0.143	0.336
48 Vdc@85°C												
Rated Torque (speed) ②③		T _{rttd}	Nm	0.65	0.56	0.41	0.88	0.79	0.58	1.55	1.46	1.24
			lb-in	5.78	4.99	3.60	7.82	7.00	5.10	13.7	12.9	11.1
Rated Speed		N _{rttd}	rpm	2000	4500	7500	1300	3000	5700	600	1500	2800
Rated Power (speed) ②③		P _{rttd}	kW	0.137	0.266	0.319	0.120	0.248	0.344	0.098	0.229	0.369
			Hp	0.183	0.358	0.428	0.161	0.333	0.461	0.131	0.324	0.494
48 Vdc@155°C												
Rated Torque (speed) ①③		T _{rttd}	Nm	0.86	0.80	0.70	1.20	1.15	1.02	2.04	1.98	1.85
			lb-in	7.60	7.11	6.19	10.65	10.14	9.07	18.0	17.5	16.4
Rated Speed		N _{rttd}	rpm	1900	4500	8000	1200	2900	5600	500	1400	2800
Rated Power (speed) ①③		P _{rttd}	kW	0.171	0.378	0.586	0.151	0.348	0.601	0.107	0.290	0.544
			Hp	0.229	0.507	0.786	0.203	0.466	0.806	0.143	0.389	0.729

- ① Motor winding at temp. rise, ΔT = 130°C, at 25°C ambient
- ② Motor winding at temp. rise, ΔT = 60°C, at 25°C ambient
- ③ All data referenced to sinusoidal commutation
- ④ May be limited at some values of V_{bus}
- ⑤ Measured at 25°C (without leads)
- ⑥ All values measured without leads
- ⑦ Estimated value
- ⑧ With housing and heat sink



TBM2G 76 Series Motor Parameters

Parameter	Tol	Symbol	Units	TBM2G-07608			TBM2G-07613			TBM2G-07626		
				A	C	D	A	C	D	A	C	D
Hot Torque Constant ①⑥⑧	+/- 10%	K _t	Nm/Arms	0.193	0.096	0.056	0.281	0.141	0.081	0.539	0.270	0.156
			lb-in/Arms	1.71	0.85	0.49	2.49	1.25	0.72	4.77	2.39	1.38
Cold Torque Constant ⑤⑨	+/- 10%	K _t	Nm/Arms	0.216	0.108	0.062	0.315	0.158	0.091	0.604	0.302	0.174
			lb-in/Arms	1.91	0.96	0.55	2.79	1.39	0.81	5.35	2.67	1.54
Hot Back EMF Constant ①⑥⑧	+/- 10%	K _e	Vrms/krpm	11.7	5.83	3.37	17.0	8.51	4.91	32.6	16.3	9.41
Cold Back EMF Constant ⑤⑧	+/- 10%	K _e	Vrms/krpm	13.1	6.53	3.77	19.1	9.53	5.50	36.5	18.3	10.5
Motor Constant ⑤	Nom	K _m	Nm/√W	0.156	0.156	0.156	0.201	2.01	0.201	0.324	0.324	0.324
			lb-in/√W	1.38	1.38	1.38	1.78	1.78	1.78	2.87	2.87	2.87
Resistance (line-line) ⑤⑧	+/- 10%	R _m	Ω	1.27	0.318	0.106	1.64	0.409	0.136	2.32	0.579	0.193
Inductance Q-Axis (line-line) ⑥⑧	+/- 20%	L _{qll}	mH	0.90	0.22	0.07	1.49	0.37	0.12	3.25	0.82	0.27

Parameter	Symbol	Unit	07608	07613	07626
			Value		
Inertia ①	J _m	kg-cm ²	0.441	0.576	0.972
		lb-in-s ²	3.90E-04	5.10E-04	8.60E-04
Weight ⑦	W	kg	0.236	0.321	0.596
		lb	0.520	0.708	1.314
Thermal Resistance	R _{thw-a}	°C/W	2.15	1.85	1.71
Pole Pairs	PP		10	10	10
Heatsink Size	7.5" x 7" x 0.375" Aluminum Plate				
Housing Geometry	Aluminum Housing [L x T]		1.35" x 0.25"	1.52" x 0.25"	2.05" x 0.25"

- ① Motor winding at temp. rise, $\delta T = 130^{\circ}\text{C}$, at 25°C ambient
- ② Motor winding at temp. rise, $\delta T = 60^{\circ}\text{C}$, at 25°C ambient
- ③ All data referenced to sinusoidal commutation
- ④ May be limited at some values of V_{bus}
- ⑤ Measured at 25°C (without leads)
- ⑥ All values measured without leads
- ⑦ Estimated value
- ⑧ With housing and heat sink

TBM2G 76 Series Motor

TBM2G 76 Series Performance Curves

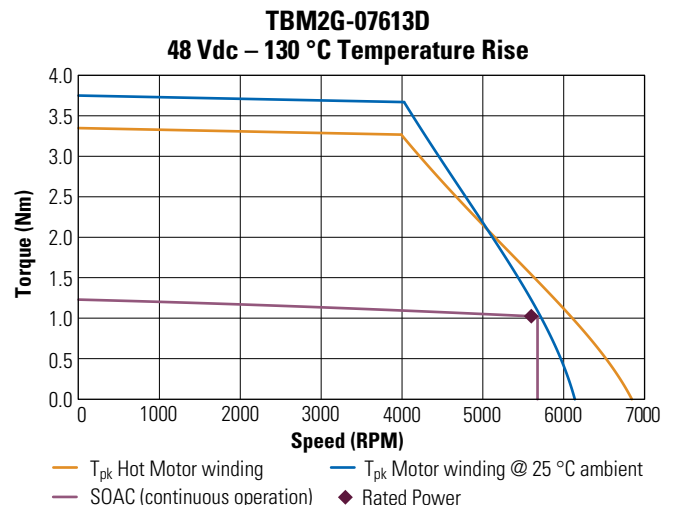
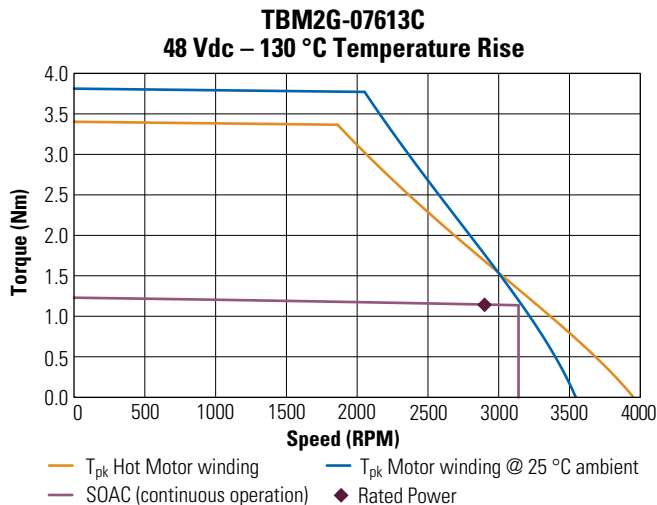
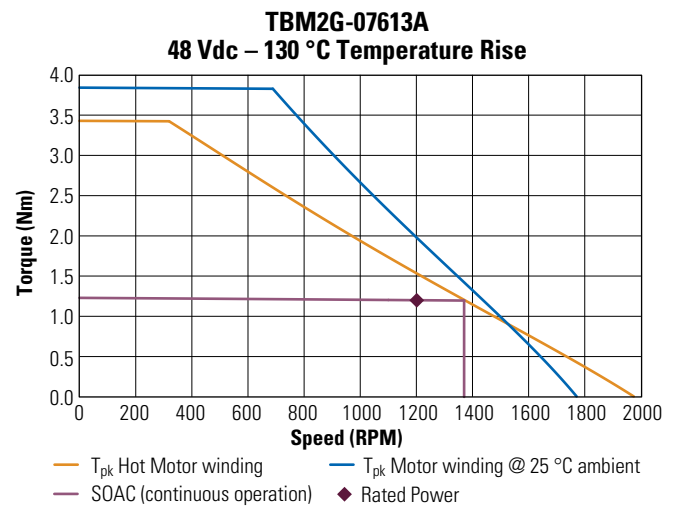
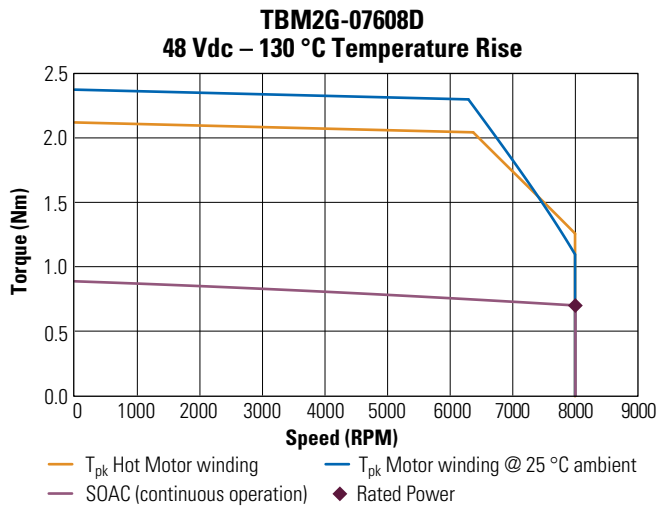
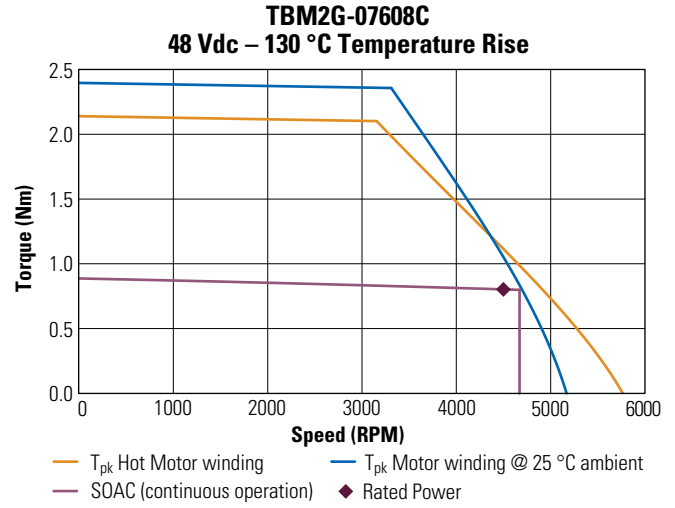
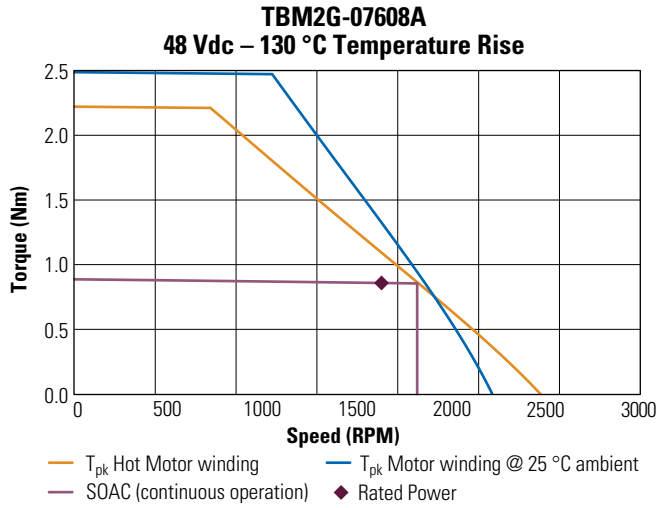

TBM2G 76 Series Performance Curves (Continued)

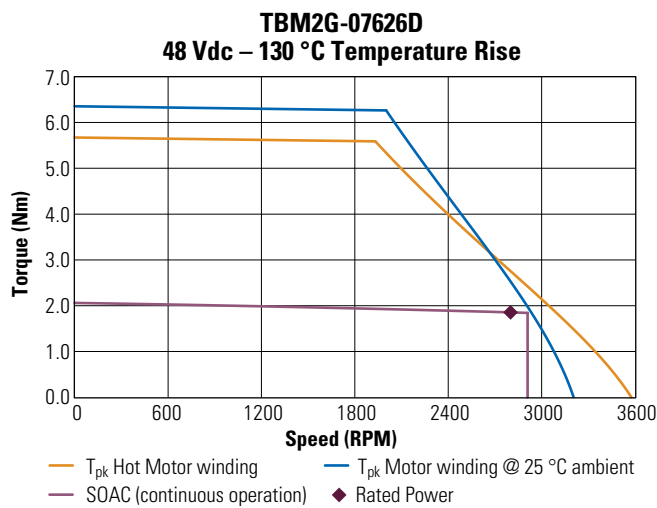
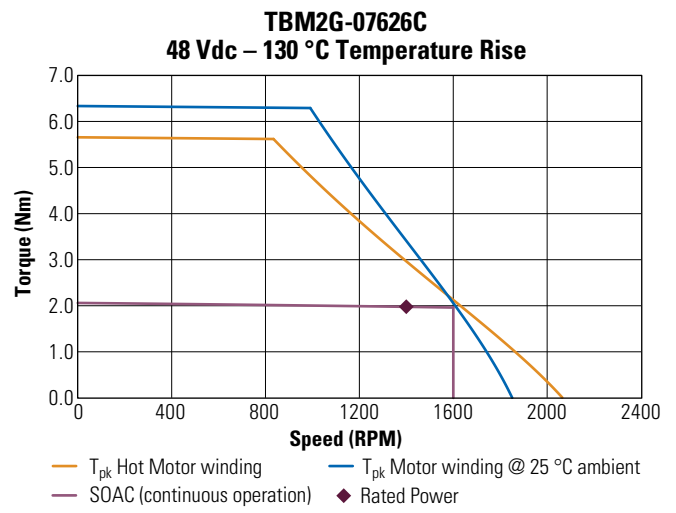
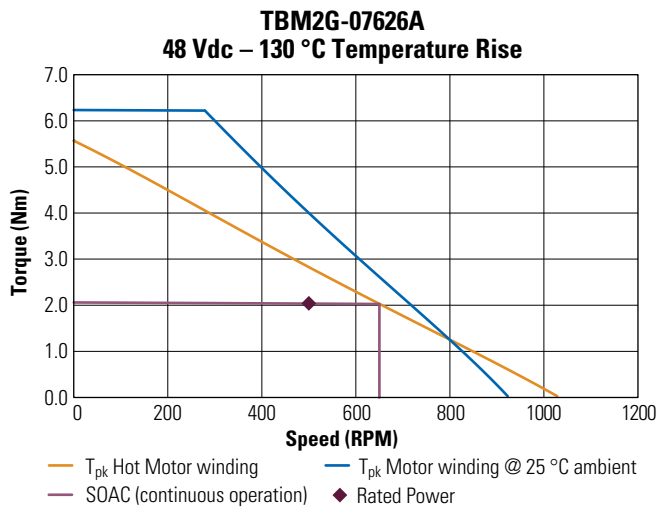

TBM2G 76 Series Motor

TBM2G 76 Series Dimensional Drawings

TBM2G-076

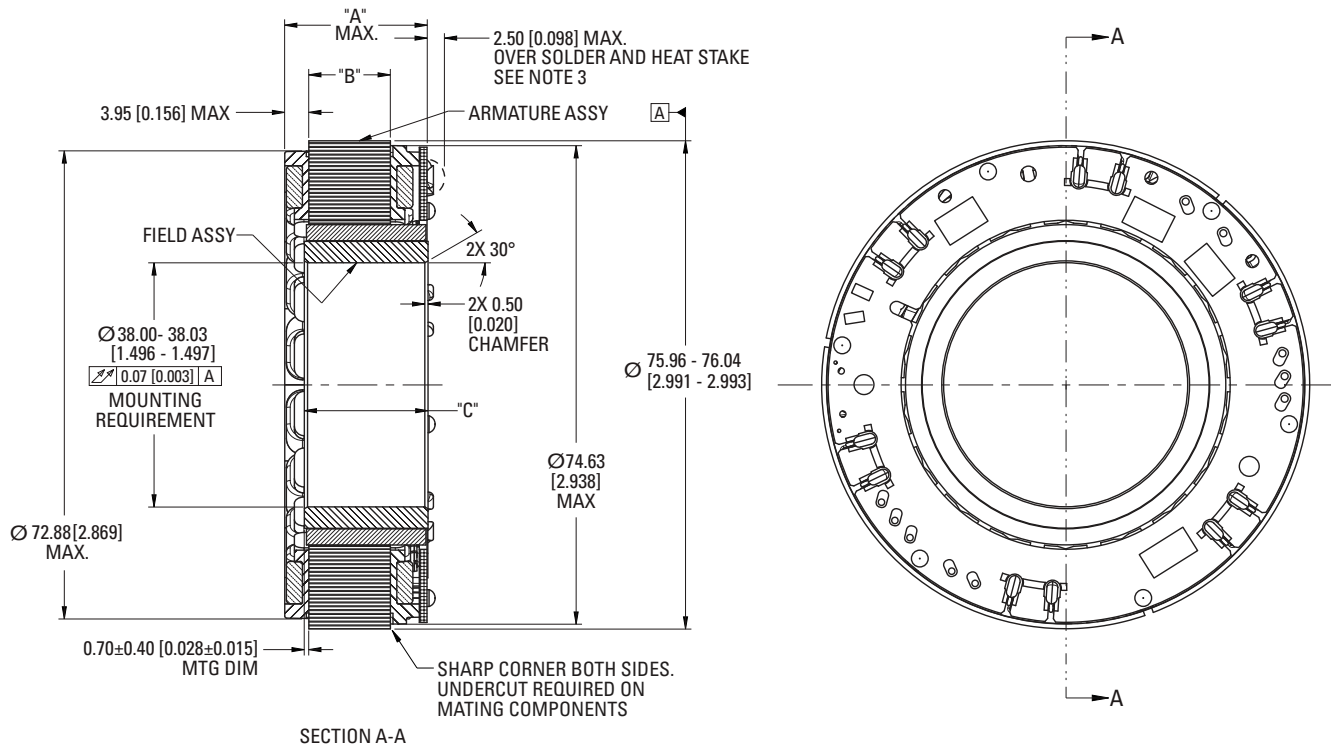

Stack Specific Dimensional Data

MODEL	"A" MAX.	"B" REF ±0.35 [0.014]	"C" ±0.08 [0.004]
TBM2G-07608	18.59 [0.732]	8.2 [0.323]	14.76 [0.581]
TBM2G-07613	23.09 [0.909]	12.70 [0.500]	19.26 [0.758]
TBM2G-07626	36.69 [1.444]	26.30 [1.035]	32.86 [1.294]

Notes:

1. All dimensions are in mm [inches] and are for reference only.
2. Motor supplied as two separate components: armature & sensor assembly and field assembly.
3. Customer must provide 0.25 [0.010] min. clearance from all solder and heat stakes.

Motor Series

Frame Size

Stack Length

Winding

Thermal Device

Sensor Option

Connection Opt.

Field Option

Custom

TBM2G 76 Series Optional Lead Specifications

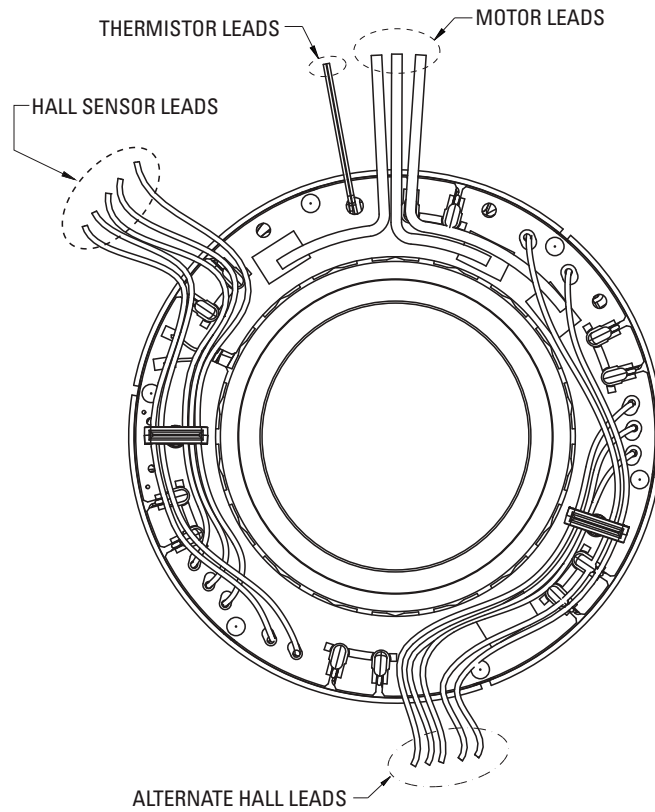

Motor Leads:

#18 AWG, ETFE Coated, Per UL Style 10086
 3 Leads, 0.5 m Length
 1 - Red, 1 - White, & 1 - Black
 Minimum Motor Lead Bend Radius 8.51 [0.335]

Hall Sensor Leads:

#26 AWG, ETFE Coated, Per UL Style 10086
 5 Leads, 0.5 m Length
 Minimum Lead Bend Radius 4.95 [0.195]

Thermistor Leads:

#26 AWG, ETFE Coated, Per UL Style 10086
 2 White Leads, 0.5 m Length
 Minimum Lead Bend Radius 4.95 [0.195]

Connection Options

PN Lead Designation	Lead Length (Min)
A	0.5 m
N	No leads

Sensor Options

PN Lead Designation	Lead Length (Min)
A	Hall Sensor Alternate Location
H	Hall Sensor
N	No Device

Thermal Device Options

PN Lead Designation	Lead Length (Min)
A	PT1000
B	3x PTC Devices
N	No Device

See Leads Connection Diagrams on page 52.

TBM2G 85 Series Motor

TBM2G 085 Series Performance Data

Parameter	Tol	Symbol	Units	TBM2G-08508			TBM2G-08513			TBM2G-08526		
				A	C	D	A	C	D	A	C	D
Rated Equivalent Line Voltage ⑥⑧		V _{bus}	Vdc	48	48	48	48	48	48	48	48	48
Max Cont. Torque for ΔT wdg. = 130°C ①④⑥⑧		T _{mc1}	Nm	1.21	1.21	1.21	1.65	1.65	1.65	2.69	2.69	2.69
			lb-in	10.7	10.7	10.7	14.6	14.6	14.6	23.8	23.8	23.8
Max Cont. Current for ΔT wdg. = 130°C ①④⑥⑧		I _{mc1}	Arms	5.90	11.8	20.4	5.71	11.4	19.8	4.68	9.36	16.2
Max Cont. Torque for ΔT wdg. = 60°C ②④⑥⑧		T _{mc2}	Nm	0.96	0.96	0.96	1.33	1.33	1.33	2.14	2.14	2.14
			lb-in	8.50	8.50	8.50	11.7	11.7	11.7	19.0	19.0	19.0
Max Cont. Current for ΔT wdg. = 60°C ②④⑥⑧		I _{mc2}	Arms	4.37	8.74	15.1	4.23	8.45	14.6	3.49	6.98	12.1
Max mechanical speed		N _{max}	rpm	8000	8000	8000	8000	8000	8000	8000	8000	8000
Peak Torque ①④		T _p	Nm	3.17	3.17	3.17	4.44	4.44	4.44	7.01	7.01	7.01
			lb-in	28.1	28.1	28.1	39.3	39.3	39.3	62.0	62.0	62.0
Peak Current ⑥⑧		I _p	Arms	17.6	35.3	61.1	17.1	34.1	59.1	14.0	28.0	48.5
24 Vdc@85°C												
Rated Torque (speed) ②③		T _{rttd}	Nm	0.93	0.89	0.79	1.30	1.25	1.15	2.12	2.07	1.97
			lb-in	8.25	7.83	7.00	11.5	11.0	10.16	18.8	18.3	17.4
Rated Speed		N _{rttd}	rpm	800	1900	3500	500	1300	2400	200	600	1200
Rated Power (speed) ②③		P _{rttd}	kW	0.078	0.176	0.290	0.068	0.170	0.208	0.044	0.130	0.247
			Hp	0.105	0.236	0.388	0.091	0.228	0.387	0.060	0.174	0.332
24 Vdc@155°C												
Rated Torque (speed) ①③		T _{rttd}	Nm	1.20	1.17	1.12	1.64	1.61	1.54	2.69	2.65	2.60
			lb-in	10.6	10.4	9.88	14.5	14.2	13.7	23.8	23.5	23.0
Rated Speed		N _{rttd}	rpm	600	1700	3400	400	1200	2400	100	500	1100
Rated Power (speed) ①③		P _{rttd}	kW	0.076	0.209	0.397	0.069	0.202	0.388	0.028	0.139	0.299
			Hp	0.101	0.280	0.533	0.092	0.271	0.520	0.038	0.186	0.401
48 Vdc@85°C												
Rated Torque (speed) ②③		T _{rttd}	Nm	0.89	0.74	0.58	1.25	1.09	0.79	2.07	1.93	1.58
			lb-in	7.83	6.55	5.09	11.0	9.67	7.03	18.3	17.1	14.0
Rated Speed		N _{rttd}	rpm	1900	4200	5900	1300	2900	4900	600	1400	2700
Rated Power (speed) ②③		P _{rttd}	kW	0.176	0.325	0.355	0.170	0.332	0.408	0.130	0.283	0.446
			Hp	0.236	0.436	0.477	0.228	0.455	0.547	0.174	0.379	0.599
48 Vdc@155°C												
Rated Torque (speed) ①③		T _{rttd}	Nm	1.17	1.09	0.91	1.61	1.52	1.32	2.65	2.56	2.39
			lb-in	10.4	9.66	8.08	14.2	13.4	11.7	23.5	22.7	21.1
Rated Speed		N _{rttd}	rpm	1700	4000	7500	1200	2800	5300	500	1400	2600
Rated Power (speed) ①③		P _{rttd}	kW	0.209	0.457	0.717	0.202	0.445	0.734	0.139	0.376	0.650
			Hp	0.280	0.613	0.962	0.271	0.597	0.985	0.186	0.504	0.871

- ① Motor winding at temp. rise, ΔT = 130°C, at 25°C ambient
- ② Motor winding at temp. rise, ΔT = 60°C, at 25°C ambient
- ③ All data referenced to sinusoidal commutation
- ④ May be limited at some values of V_{bus}
- ⑤ Measured at 25°C (without leads)
- ⑥ All values measured without leads
- ⑦ Estimated value
- ⑧ With housing and heat sink



TBM2G 085 Series Motor Parameters

Parameter	Tol	Symbol	Units	TBM2G-08508			TBM2G-08513			TBM2G-08526		
				A	C	D	A	C	D	A	C	D
Hot Torque Constant ①⑥⑧	+/- 10%	K _t	Nm/Arms	0.206	0.103	0.059	0.294	0.147	0.085	0.575	0.288	0.166
			lb-in/Arms	1.82	0.91	0.53	2.60	1.30	0.75	5.09	2.55	1.47
Cold Torque Constant ⑤⑨	+/- 10%	K _t	Nm/Arms	0.230	0.115	0.066	0.330	0.165	0.095	0.644	0.322	0.186
			lb-in/Arms	2.04	1.02	0.59	2.92	1.46	0.84	5.70	2.85	1.65
Hot Back EMF Constant ①⑥⑧	+/- 10%	K _e	Vrms/krpm	12.4	6.21	3.59	17.8	8.89	5.13	34.8	17.4	10.0
Cold Back EMF Constant ⑤⑧	+/- 10%	K _e	Vrms/krpm	13.9	6.96	4.02	19.9	9.96	5.75	39.0	19.5	11.2
Motor Constant ⑤	Nom	K _m	Nm/√W	0.203	0.203	0.203	0.271	0.271	0.271	0.419	0.419	0.419
			lb-in/√W	1.79	1.79	1.79	2.40	2.40	2.40	3.70	3.70	3.70
Resistance (line-line) ⑤⑧	+/- 10%	R _m	Ω	0.860	0.215	0.072	0.984	0.246	0.082	1.58	0.395	0.132
Inductance Q-Axis (line-line) ⑥⑧	+/- 20%	L _{qll}	mH	1.13	0.28	0.09	1.52	0.38	0.13	2.68	0.67	0.22

Parameter	Symbol	Unit	08508	08513	08526
			Value		
Inertia ①	J _m	kg-cm ²	0.593	0.763	1.27
		lb-in-s ²	5.25E-04	6.75E-04	1.12E-03
Weight ⑦	W	kg	0.295	0.403	0.723
		lb	0.650	0.888	1.594
Thermal Resistance	R _{thw-a}	°C/W	1.93	1.80	1.67
Pole Pairs	PP		10	10	10
Heatsink Size	7.5" x 7" x 0.375" Aluminum Plate				
Housing Geometry	Aluminum Housing [L x T]		1.36" x 0.25"	1.54" x 0.25"	2.06" x 0.25"

- ① Motor winding at temp. rise, $\delta T = 130^{\circ}\text{C}$, at 25°C ambient
- ② Motor winding at temp. rise, $\delta T = 60^{\circ}\text{C}$, at 25°C ambient
- ③ All data referenced to sinusoidal commutation
- ④ May be limited at some values of V_{bus}
- ⑤ Measured at 25°C (without leads)
- ⑥ All values measured without leads
- ⑦ Estimated value
- ⑧ With housing and heat sink

TBM2G 85 Series Motor

TBM2G 85 Series Performance Curves

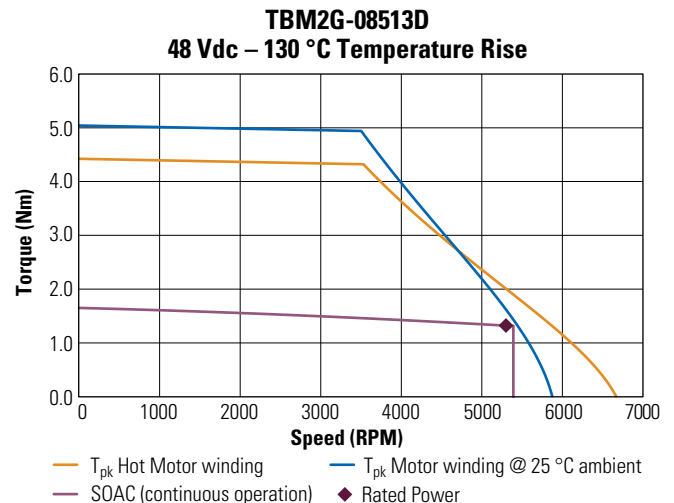
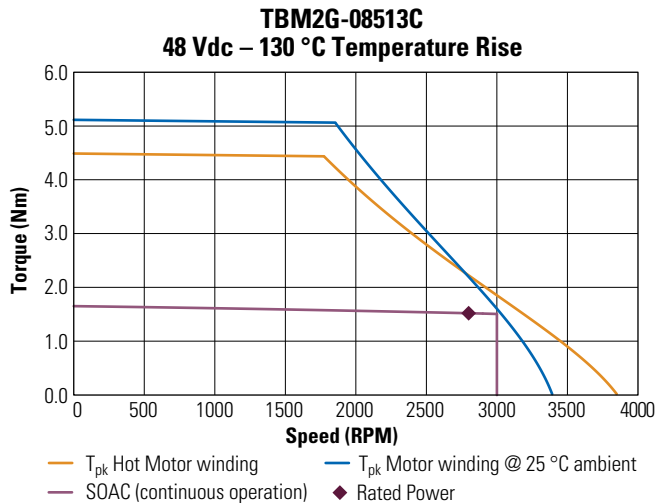
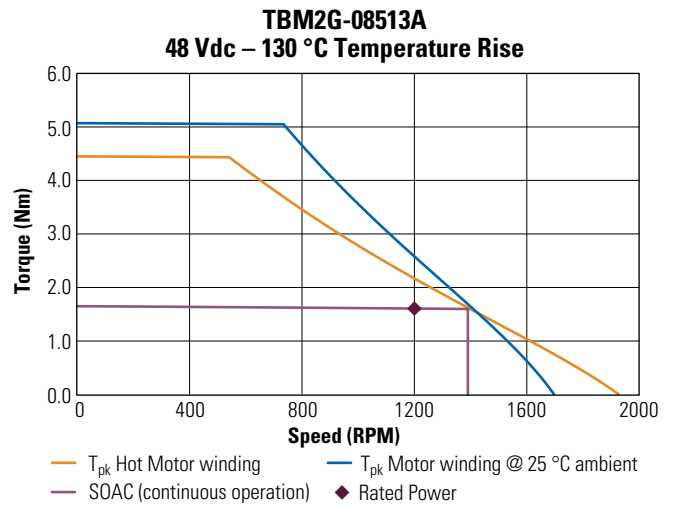
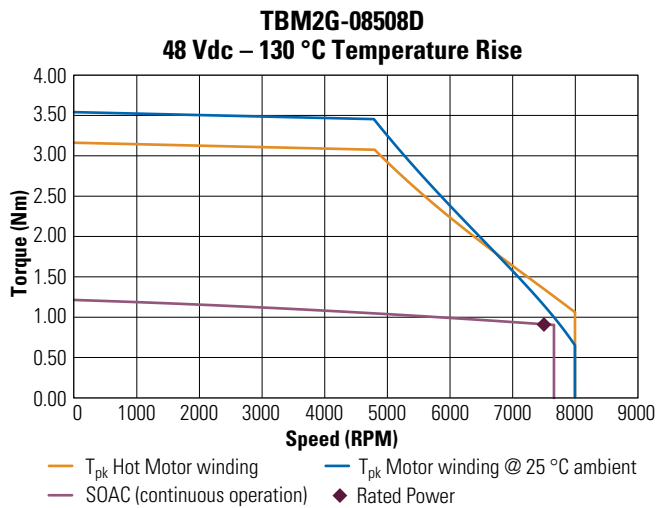
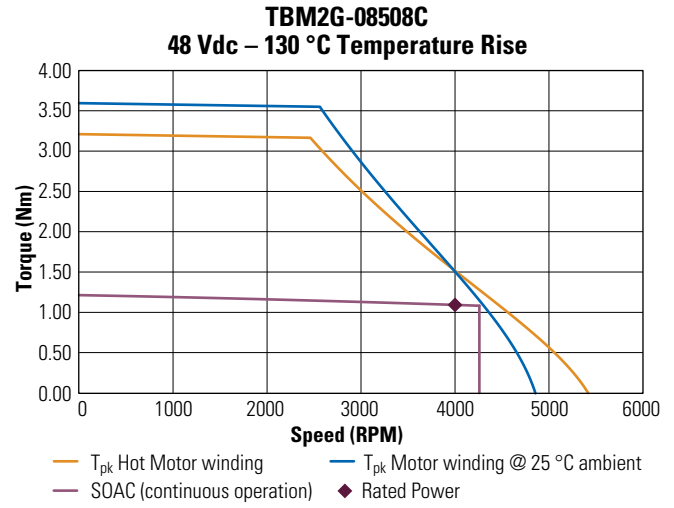
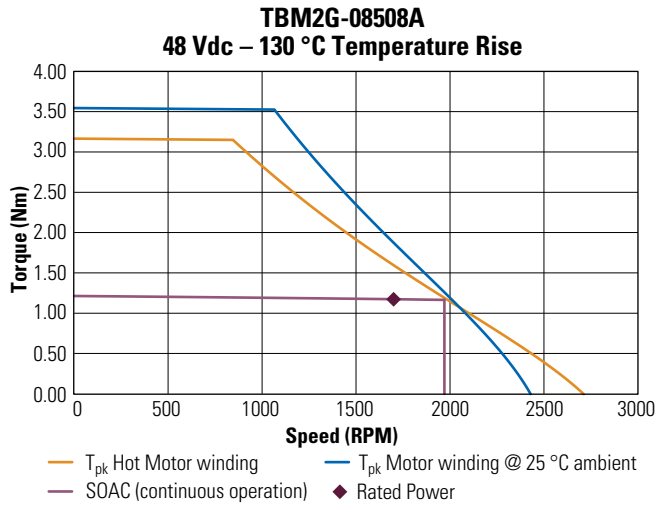

TBM2G 85 Series Performance Curves (Continued)

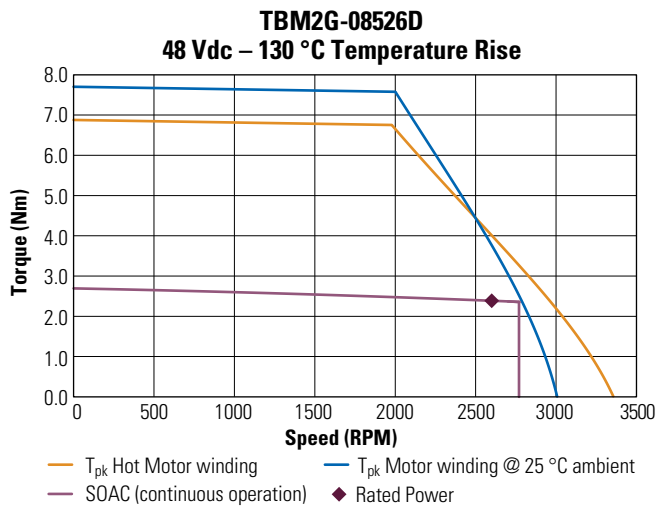
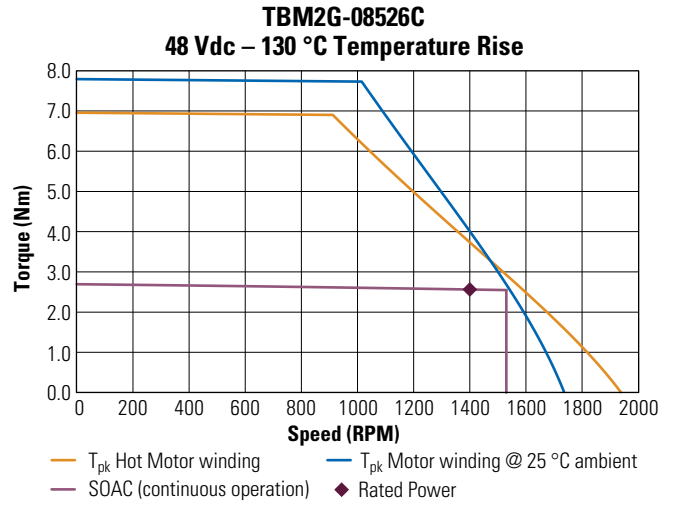
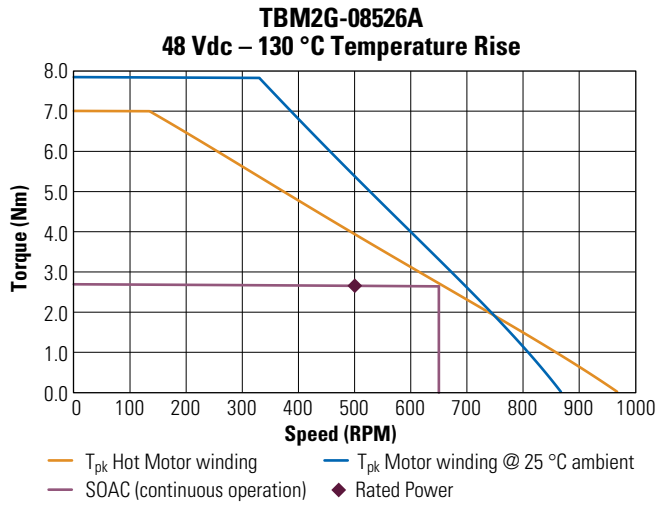

TBM2G 85 Series Motor

TBM2G 85 Series Dimensional Drawings

TBM2G-085

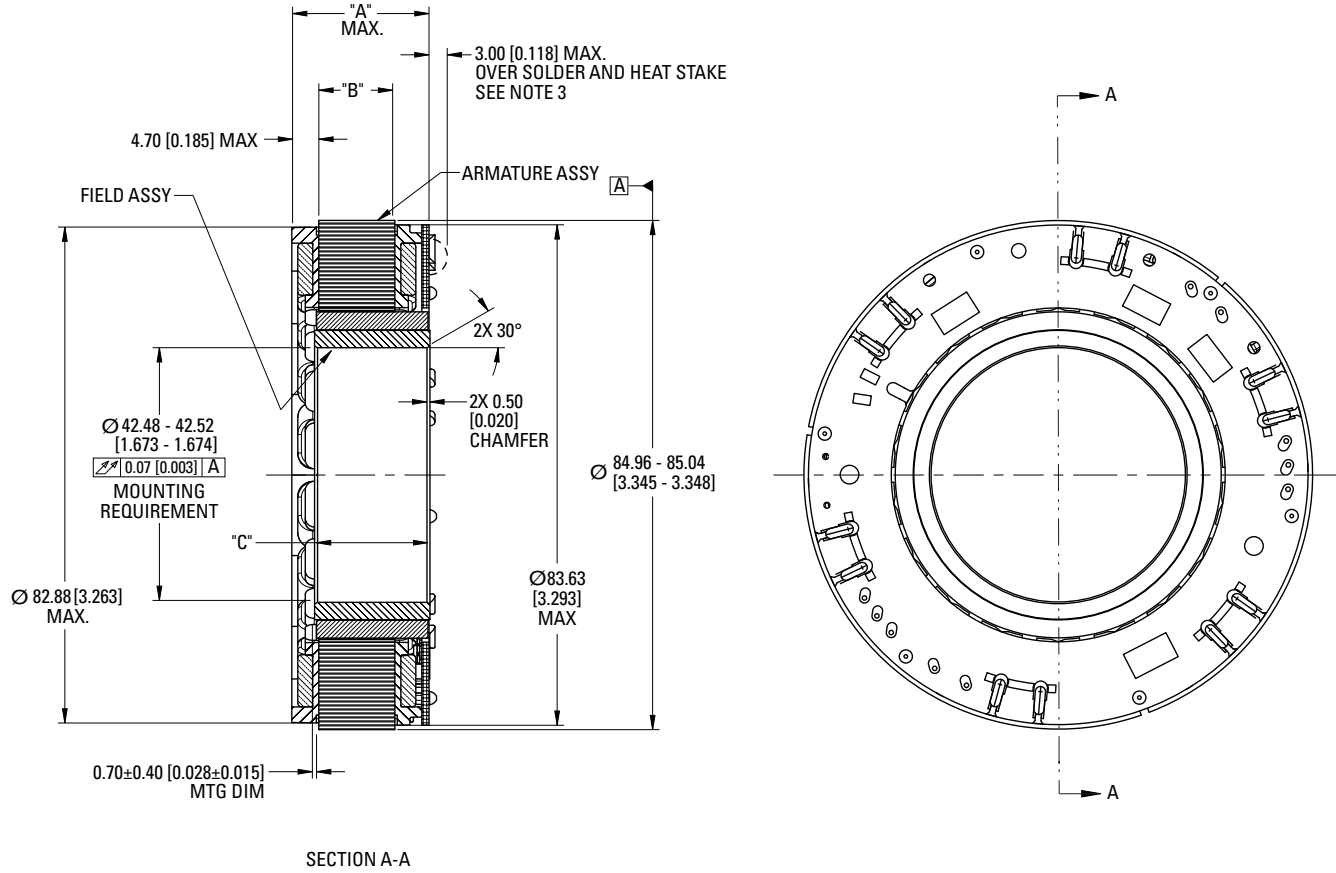

Stack Specific Dimensional Data

MODEL	"A" MAX.	"B" REF ±0.35 [0.014]	"C" ±0.08 [0.004]
TBM2G-08508	19.34 [0.761]	8.2 [0.323]	14.76 [0.581]
TBM2G-08513	23.84 [0.939]	12.70 [0.500]	19.26 [0.758]
TBM2G-08526	37.44 [1.474]	26.30 [1.035]	32.86 [1.294]

Notes:

1. All dimensions are in mm [inches] and are for reference only.
2. Motor supplied as two separate components: armature & sensor assembly and field assembly.
3. Customer must provide 0.25 [0.010] min. clearance from all solder and heat stakes.

TBM2G 85 Series Optional Lead Specifications

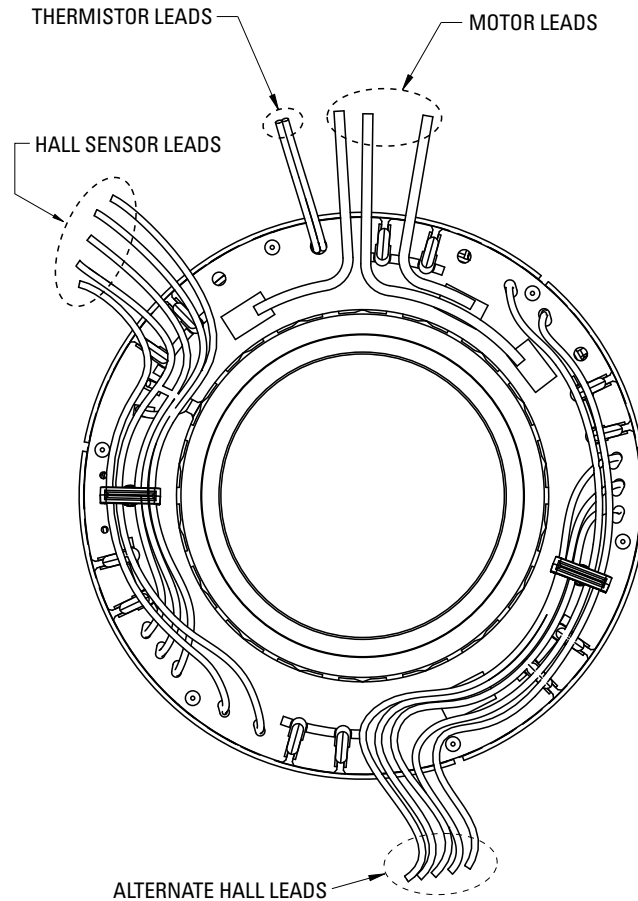

Motor Leads:

#16 AWG, ETFE Coated, Per UL Style 10086
 3 Leads, 0.5 m Length
 1 - Red, 1 - White, & 1 - Black
 Minimum Motor Lead Bend Radius 9.91 [0.390]

Hall Sensor Leads:

#26 AWG, ETFE Coated, Per UL Style 10086
 5 Leads, 0.5 m Length
 Minimum Lead Bend Radius 4.95 [0.195]

Thermistor Leads:

#26 AWG, ETFE Coated, Per UL Style 10086
 2 White Leads, 0.5 m Length
 Minimum Lead Bend Radius 4.95 [0.195]

Connection Options

PN Lead Designation	Lead Length (Min)
A	0.5 m
N	No leads

Sensor Options

PN Lead Designation	Lead Length (Min)
A	Hall Sensor Alternate Location
H	Hall Sensor
N	No Device

Thermal Device Options

PN Lead Designation	Lead Length (Min)
A	PT1000
B	3x PTC Devices
N	No Device

See Leads Connection Diagrams on page 52.

TBM2G 94 Series Motor

TBM2G 94 Series Performance Data

Parameter	Tol	Symbol	Units	TBM2G-09408			TBM2G-09413			TBM2G-09426		
				A	C	D	A	C	D	A	C	D
Rated Equivalent Line Voltage ⑥⑧		V _{bus}	Vdc	48	48	48	48	48	48	48	48	48
Max Cont. Torque for ΔT wdg. = 130°C ①④⑥⑧		T _{mc1}	Nm	1.58	1.58	1.58	2.05	2.01	2.05	3.67	3.67	3.67
			lb-in	14.0	14.0	14.0	18.1	17.8	18.1	32.5	32.5	32.5
Max Cont. Current for ΔT wdg. = 130°C ①④⑥⑧		I _{mc1}	Arms	8.10	16.2	28.0	7.56	14.8	26.1	6.60	13.2	22.9
Max Cont. Torque for ΔT wdg. = 60°C ②④⑥⑧		T _{mc2}	Nm	1.20	1.20	1.20	1.56	1.53	1.56	2.75	2.75	2.75
			lb-in	10.6	10.6	10.6	13.8	13.6	13.8	24.4	24.4	24.4
Max Cont. Current for ΔT wdg. = 60°C ②④⑥⑧		I _{mc2}	Arms	5.76	11.5	19.9	5.40	10.6	18.7	4.72	9.43	16.3
Max mechanical speed		N _{max}	rpm	8000	8000	8000	8000	8000	8000	8000	8000	8000
Peak Torque ①④		T _p	Nm	3.92	3.92	3.92	5.06	4.96	5.04	8.98	9.01	8.99
			lb-in	34.7	34.7	34.7	44.7	43.9	44.6	79.5	79.7	79.6
Peak Current ⑥⑧		I _p	Arms	24.2	48.4	83.8	22.6	44.3	78.1	19.7	39.5	68.3
24 Vdc@85°C												
Rated Torque (speed) ②③		T _{rttd}	Nm	1.17	1.09	0.88	1.53	1.41	1.22	2.73	2.64	2.46
			lb-in	10.3	9.64	7.75	13.5	12.5	10.8	24.2	23.4	21.8
Rated Speed		N _{rttd}	rpm	900	2100	3900	600	1500	2700	200	700	1300
Rated Power (speed) ②③		P _{rttd}	kW	0.110	0.240	0.357	0.096	0.221	0.345	0.057	0.194	0.355
			Hp	0.148	0.321	0.479	0.129	0.297	0.463	0.077	0.260	0.449
24 Vdc@155°C												
Rated Torque (speed) ①③		T _{rttd}	Nm	1.57	1.53	1.44	2.03	1.95	1.88	3.66	3.62	3.54
			lb-in	13.9	13.5	12.7	18.0	17.3	16.6	32.4	32.0	31.3
Rated Speed		N _{rttd}	rpm	800	2000	3800	500	1400	2700	200	600	1200
Rated Power (speed) ①③		P _{rttd}	kW	0.131	0.320	0.571	0.106	0.286	0.533	0.077	0.227	0.444
			Hp	0.176	0.429	0.766	0.143	0.383	0.714	0.103	0.305	0.596
48 Vdc@85°C												
Rated Torque (speed) ②③		T _{rttd}	Nm	1.09	0.77	0.77	1.44	1.07	1.01	2.64	2.38	1.83
			lb-in	9.64	6.80	6.79	12.7	9.51	8.92	23.4	21.0	16.2
Rated Speed		N _{rttd}	rpm	2100	4500	4100	1500	3200	3300	700	1500	2400
Rated Power (speed) ②③		P _{rttd}	kW	0.240	0.362	0.329	0.226	0.360	0.348	0.194	0.373	0.460
			Hp	0.321	0.485	0.442	0.303	0.483	0.467	0.260	0.500	0.617
48 Vdc@155°C												
Rated Torque (speed) ①③		T _{rttd}	Nm	1.53	1.39	1.03	1.99	1.81	1.41	3.62	3.48	3.17
			lb-in	13.5	12.3	9.08	17.6	16.0	12.5	32.0	30.8	28.1
Rated Speed		N _{rttd}	rpm	2000	4400	8000	1400	3100	5900	600	1500	2700
Rated Power (speed) ①③		P _{rttd}	kW	0.320	0.643	0.860	0.292	0.587	0.874	0.227	0.547	0.897
			Hp	0.429	0.862	1.153	0.391	0.788	1.172	0.305	0.734	1.203

- ① Motor winding at temp. rise, ΔT = 130°C, at 25°C ambient
- ② Motor winding at temp. rise, ΔT = 60°C, at 25°C ambient
- ③ All data referenced to sinusoidal commutation
- ④ May be limited at some values of V_{bus}
- ⑤ Measured at 25°C (without leads)
- ⑥ All values measured without leads
- ⑦ Estimated value
- ⑧ With housing and heat sink

TBM2G 94 Series Motor Parameters

Parameter	Tol	Symbol	Units	TBM2G-09408			TBM2G-09413			TBM2G-09426		
				A	C	D	A	C	D	A	C	D
Hot Torque Constant ①⑥⑧	+/- 10%	K _t	Nm/Arms	0.193	0.097	0.056	0.269	0.134	0.078	0.546	0.273	0.158
			lb-in/Arms	1.71	0.86	0.49	2.38	1.19	0.69	4.83	2.42	1.40
Cold Torque Constant ⑤⑧	+/- 10%	K _t	Nm/Arms	0.217	0.108	0.063	0.301	0.151	0.087	0.612	0.306	0.177
			lb-in/Arms	1.92	0.96	0.55	2.66	1.33	0.77	5.41	2.71	1.56
Hot Back EMF Constant ①⑥⑧	+/- 10%	K _e	Vrms/krpm	11.7	5.85	3.38	16.3	8.13	4.69	33.0	16.5	9.53
Cold Back EMF Constant ⑤⑧	+/- 10%	K _e	Vrms/krpm	13.1	6.55	3.78	18.2	9.10	5.25	37.0	18.5	10.7
Motor Constant ⑤	Nom	K _m	Nm/√W	0.263	0.263	0.263	0.331	0.325	0.331	0.528	0.528	0.528
			lb-in/√W	2.33	2.33	2.33	2.93	2.88	2.93	4.67	4.67	4.67
Resistance (line-line) ⑤⑧	+/- 10%	R _m	Ω	0.452	0.113	0.038	0.550	0.143	0.046	0.896	0.224	0.075
Inductance Q-Axis (line-line) ⑥⑧	+/- 20%	L _{qll}	mH	0.70	0.18	0.06	1.07	0.27	0.09	2.17	0.54	0.18

Parameter	Symbol	Unit	09408	09413	09426
			Value		
Inertia ⑦	J _m	kg-cm ²	0.861	1.120	1.900
		lb-in-s ²	7.62E-04	9.91E-04	1.68E-03
Weight ⑦	W	kg	0.374	0.510	0.915
		lb	0.825	1.124	2.017
Thermal Resistance	R _{thw-a}	°C/W	1.95	1.84	1.48
Pole Pairs	PP		10	10	10
Heatsink Size	10" x 10" x 0.375" Aluminum Plate				
Housing Geometry	Aluminum Housing [L x T]		1.34" x 0.25"	1.52" x 0.25"	2.05" x 0.25"

- ① Motor winding at temp. rise, δT = 130°C, at 25°C ambient
- ② Motor winding at temp. rise, δT = 60°C, at 25°C ambient
- ③ All data referenced to sinusoidal commutation
- ④ May be limited at some values of V_{bus}
- ⑤ Measured at 25°C (without leads)
- ⑥ All values measured without leads
- ⑦ Estimated value
- ⑧ With housing and heat sink

TBM2G 94 Series Motor

TBM2G 94 Series Performance Curves

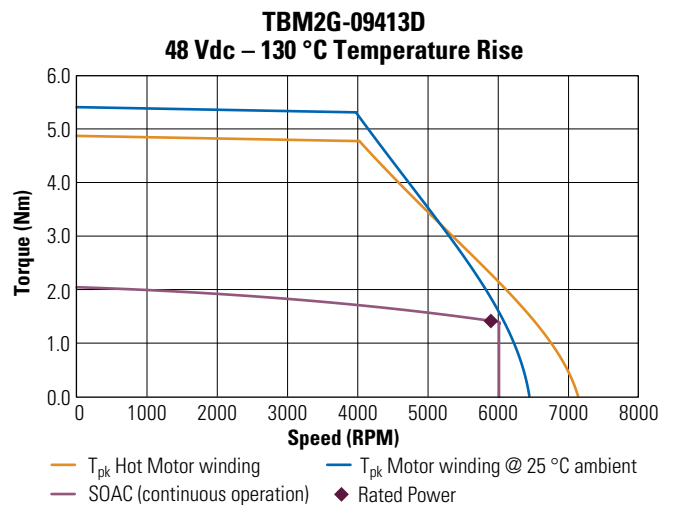
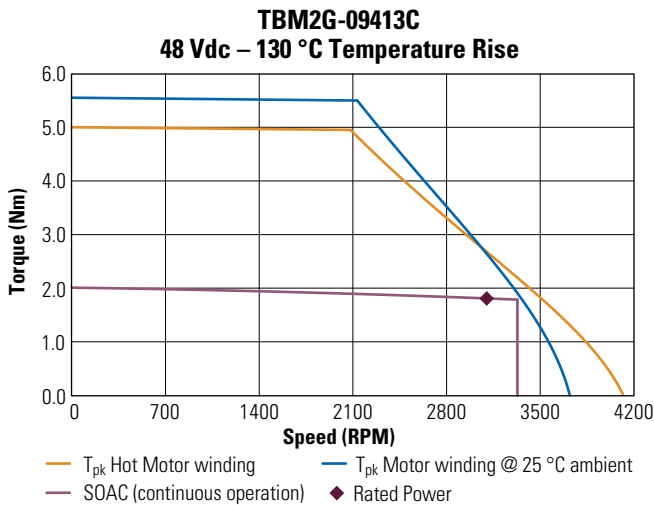
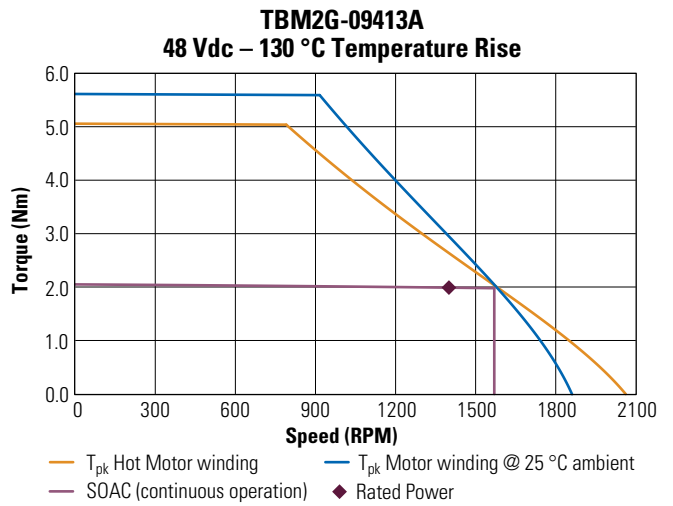
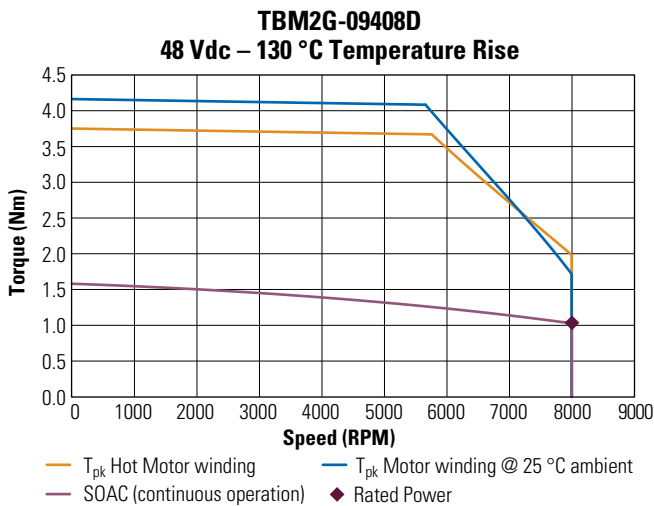
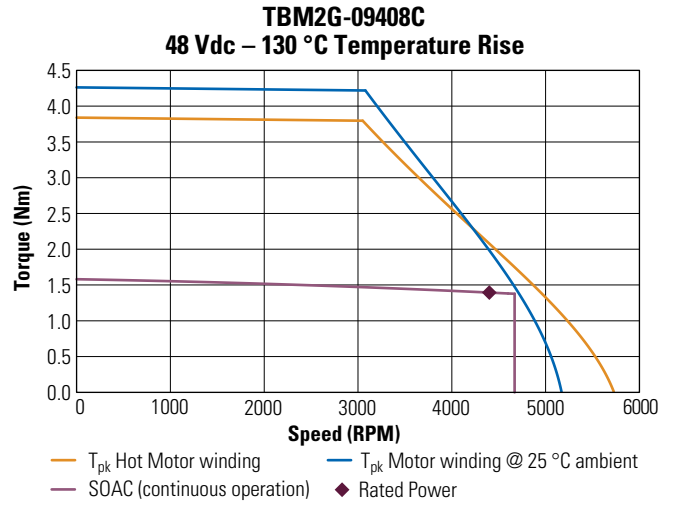
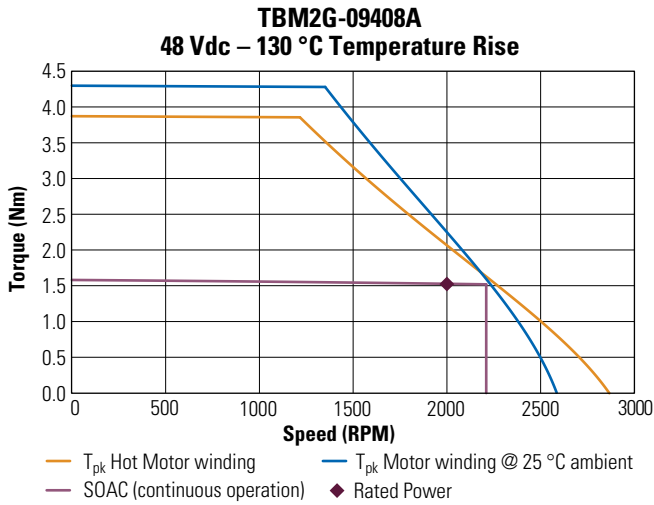

TBM2G 94 Series Performance Curves (Continued)

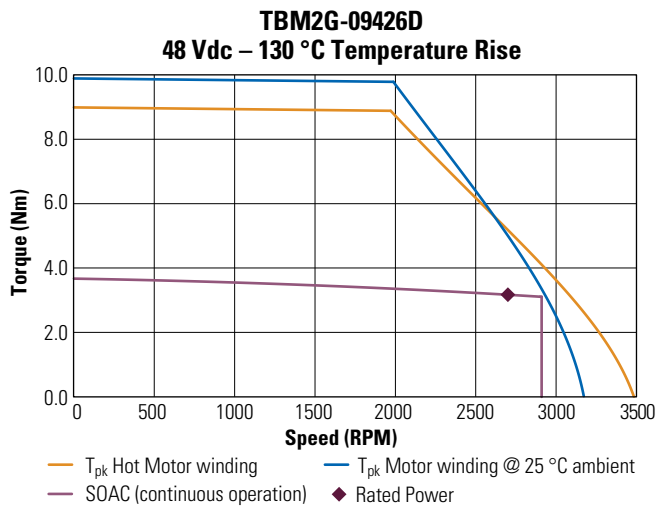
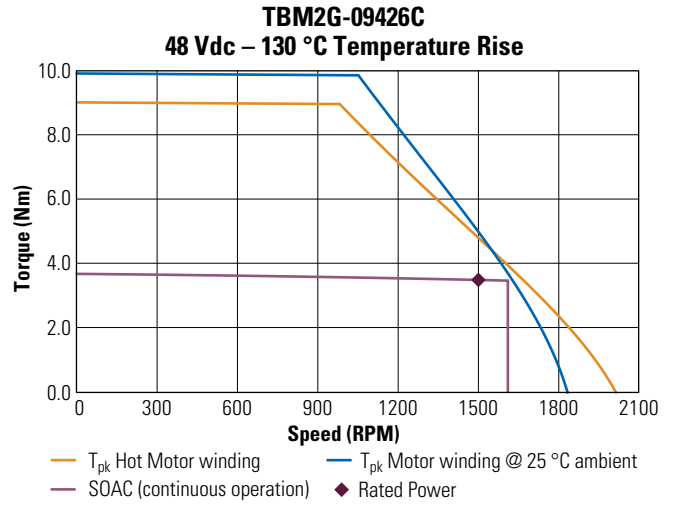
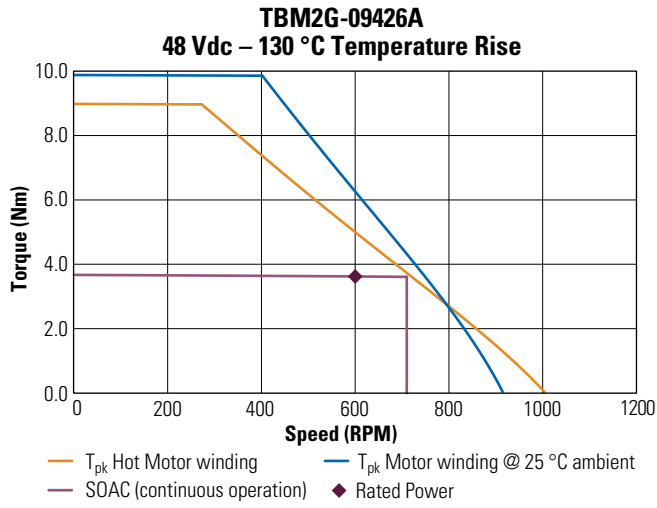

TBM2G 94 Series Motor

TBM2G 94 Series Dimensional Drawings

TBM2G-094

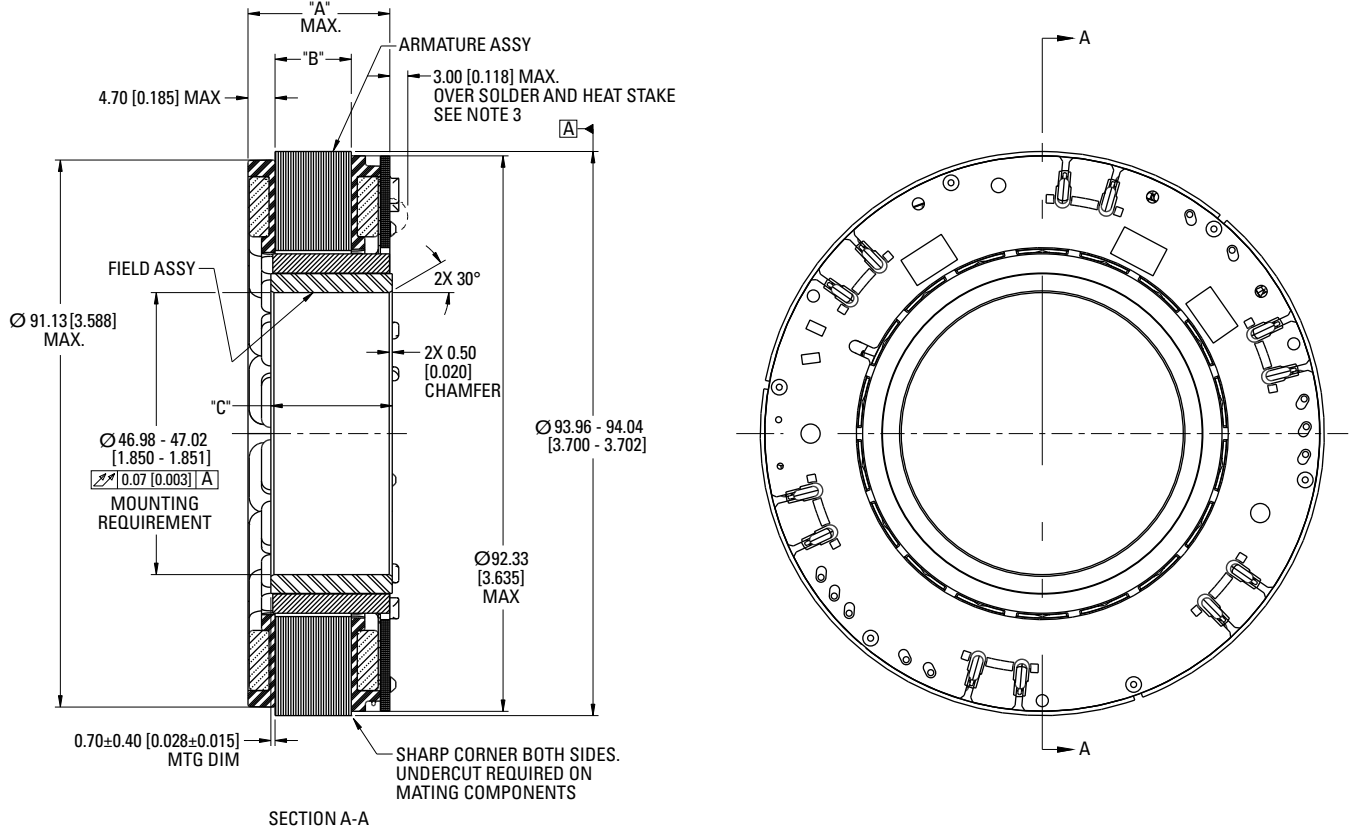

Stack Specific Dimensional Data

MODEL	"A" MAX.	"B" REF ±0.35 [0.014]	"C" ±0.08 [0.004]
TBM2G-09408	19.69 [0.775]	8.2 [0.323]	15.73 [0.619]
TBM2G-09413	24.19 [0.952]	12.70 [0.500]	20.23 [0.797]
TBM2G-09426	37.79 [1.488]	26.30 [1.035]	33.33 [1.312]

Notes:

1. All dimensions are in mm [inches] and are for reference only.
2. Motor supplied as two separate components: armature & sensor assembly and field assembly.
3. Customer must provide 0.25 [0.010] min. clearance from all solder and heat stakes.

TBM2G 94 Series Optional Leads Specifications

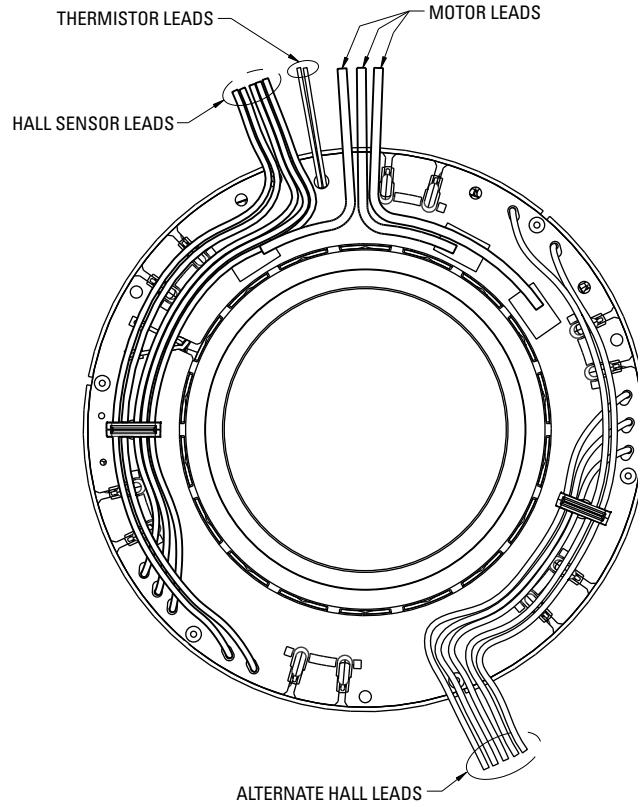

Motor Leads:

#14 AWG, ETFE Coated, Per UL Style 10086
 3 Leads, 0.5 m Length
 1 - Red, 1 - White, & 1 - Black
 Minimum Motor Lead Bend Radius 11.3 [0.445]

Hall Sensor Leads:

#26 AWG, ETFE Coated, Per UL Style 10086
 5 Leads, 0.5 m Length
 Minimum Lead Bend Radius 4.95 [0.195]

Thermistor Leads:

#26 AWG, ETFE Coated, Per UL Style 10086
 2 White Leads, 0.5 m Length
 Minimum Lead Bend Radius 4.95 [0.195]

Connection Options

PN Lead Designation	Lead Length (Min)
A	0.5 m
N	No leads

Sensor Options

PN Lead Designation	Lead Length (Min)
A	Hall Sensor Alternate Location
H	Hall Sensor
N	No Device

Thermal Device Options

PN Lead Designation	Lead Length (Min)
A	PT1000
B	3x PTC Devices
N	No Device

See Leads Connection Diagrams on page 52.

TBM2G 115 Series Motor

TBM2G 115 Series Performance Data

Parameter	Tol	Symbol	Units	TBM2G-11508			TBM2G-11513			TBM2G-11526		
				A	C	D	A	C	D	A	C	D
Rated Equivalent Line Voltage ⑥⑧		V _{bus}	Vdc	48	48	48	48	48	48	48	48	48
Max Cont. Torque for ΔT wdg. = 130°C ①④⑥⑧		T _{mc1}	Nm	1.90	1.90	1.90	3.04	3.04	3.04	6.03	6.03	6.03
			lb-in	16.8	16.8	16.8	26.9	26.9	26.9	53.3	53.3	53.3
Max Cont. Current for ΔT wdg. = 130°C ①④⑥⑧		I _{mc1}	Arms	4.57	22.8	39.6	4.75	23.8	41.2	4.81	24.0	41.6
Max Cont. Torque for ΔT wdg. = 60°C ②④⑥⑧		T _{mc2}	Nm	1.51	1.51	1.51	2.40	2.40	2.40	4.71	4.71	4.71
			lb-in	13.4	13.4	13.4	21.2	21.2	21.2	41.7	41.7	41.7
Max Cont. Current for ΔT wdg. = 60°C ②④⑥⑧		I _{mc2}	Arms	3.40	17.0	29.4	3.51	17.6	30.4	3.51	17.5	30.4
Max mechanical speed		N _{max}	rpm	8000	8000	8000	8000	8000	8000	8000	8000	8000
Peak Torque ①④		T _p	Nm	4.70	4.69	4.68	7.41	7.41	7.41	12.7	14.5	14.5
			lb-in	41.6	41.5	41.4	65.6	65.6	65.6	112	128	128
Peak Current ⑥⑧		I _p	Arms	13.7	68.3	118	14.2	71.0	123	12.6	71.9	125
24 Vdc@85°C												
Rated Torque (speed) ②③		T _{rttd}	Nm	1.50	1.22	0.97	2.38	2.09	1.55	-	4.41	3.81
			lb-in	13.3	10.8	8.58	21.1	18.5	13.8	-	39.0	33.8
Rated Speed		N _{rttd}	rpm	300	2500	3400	200	1600	2800	-	800	1500
Rated Power (speed) ②③		P _{rttd}	kW	0.047	0.319	0.345	0.050	0.351	0.456	-	0.369	0.599
			Hp	0.063	0.428	0.463	0.3067	0.470	0.611	-	0.495	0.803
24 Vdc@155°C												
Rated Torque (speed) ①③		T _{rttd}	Nm	1.90	1.75	1.49	3.04	2.90	2.64	-	5.89	5.63
			lb-in	16.8	15.5	13.2	26.9	25.5	23.4	-	52.1	49.8
Rated Speed		N _{rttd}	rpm	200	2400	4500	100	1500	2800	-	700	1400
Rated Power (speed) ①③		P _{rttd}	kW	0.040	0.441	0.704	0.032	0.455	0.774	-	0.432	0.825
			Hp	0.053	0.591	0.944	0.043	0.610	1.04	-	0.579	1.106
48 Vdc@85°C												
Rated Torque (speed) ②③		T _{rttd}	Nm	1.46	0.95	0.93	2.35	1.53	1.51	4.67	3.45	3.01
			lb-in	12.9	8.40	8.23	20.8	13.5	13.3	41.3	30.6	26.7
Rated Speed		N _{rttd}	rpm	800	3400	3100	500	2800	2600	200	1800	2000
Rated Power (speed) ②③		P _{rttd}	kW	0.123	0.338	0.302	0.123	0.448	0.410	0.098	0.651	0.631
			Hp	0.164	0.453	0.405	0.165	0.601	0.550	0.131	0.873	0.846
48 Vdc@155°C												
Rated Torque (speed) ①③		T _{rttd}	Nm	1.87	1.34	1.17	3.02	2.48	1.89	6.01	5.52	4.41
			lb-in	16.6	11.9	10.4	26.7	22.0	16.7	53.2	48.9	39.1
Rated Speed		N _{rttd}	rpm	700	5400	5800	400	3400	4900	200	1600	3100
Rated Power (speed) ①③		P _{rttd}	kW	0.137	0.759	0.711	0.126	0.884	0.969	0.126	0.925	1.43
			Hp	0.184	1.02	0.954	0.17	1.19	1.30	0.169	1.241	1.922

- ① Motor winding at temp. rise, ΔT = 130°C, at 25°C ambient
- ② Motor winding at temp. rise, ΔT = 60°C, at 25°C ambient
- ③ All data referenced to sinusoidal commutation
- ④ May be limited at some values of V_{bus}
- ⑤ Measured at 25°C (without leads)
- ⑥ All values measured without leads
- ⑦ Estimated value
- ⑧ With housing and heat sink

TBM2G 115 Series Motor Parameters

Parameter	Tol	Symbol	Units	TBM2G-11508			TBM2G-11513			TBM2G-11526		
				A	C	D	A	C	D	A	C	D
Hot Torque Constant ①⑥⑧	+/- 10%	K _t	Nm/Arms	0.417	0.083	0.048	0.641	0.128	0.074	1.26	0.252	0.145
			lb-in/Arms	3.69	0.74	0.43	5.67	1.13	0.66	11.1	2.23	1.29
Cold Torque Constant ⑤⑨	+/- 10%	K _t	Nm/Arms	0.467	0.093	0.054	0.718	0.144	0.083	1.41	0.282	0.163
			lb-in/Arms	4.13	0.83	0.48	6.36	1.27	0.73	12.5	2.50	1.44
Hot Back EMF Constant ①⑥⑧	+/- 10%	K _e	Vrms/krpm	25.2	5.04	2.91	38.8	7.75	4.48	76.2	15.2	8.79
Cold Back EMF Constant ⑤⑧	+/- 10%	K _e	Vrms/krpm	28.2	5.64	3.26	43.4	8.68	5.01	85.3	17.1	9.8
Motor Constant ⑤	Nom	K _m	Nm/√W	0.310	0.310	0.310	0.464	0.464	0.464	0.802	0.802	0.802
			lb-in/√W	2.74	2.74	2.74	4.10	4.10	4.10	7.09	7.09	7.09
Resistance (line-line) ⑤⑧	+/- 10%	R _m	Ω	1.51	0.061	0.020	1.60	0.064	0.021	2.06	0.083	0.028
Inductance Q-Axis (line-line) ⑥⑧	+/- 20%	L _{qll}	mH	3.29	0.13	0.04	4.88	0.20	0.07	9.68	0.39	0.13

Parameter	Symbol	Unit	11508	11513	11526
			Value		
Inertia ⑦	J _m	kg-cm ²	1.600	2.080	3.550
		lb-in-s ²	1.42E-03	1.84E-03	3.14E-03
Weight ⑦	W	kg	0.644	0.838	1.43
		lb	1.420	1.847	3.15
Thermal Resistance	R _{thw-a}	°C/W	1.83	1.60	1.21
Pole Pairs	PP		10	10	10
Heatsink Size	12" x 12" x 0.5" Aluminum Plate				
Housing Geometry	Aluminum Housing [L x T]		1.69" x 0.25"	1.86" x 0.25"	2.40" x 0.25"

- ① Motor winding at temp. rise, δT = 130°C, at 25°C ambient
- ② Motor winding at temp. rise, δT = 60°C, at 25°C ambient
- ③ All data referenced to sinusoidal commutation
- ④ May be limited at some values of V_{bus}
- ⑤ Measured at 25°C (without leads)
- ⑥ All values measured without leads
- ⑦ Estimated value
- ⑧ With housing and heat sink

TBM2G 115 Series Motor

TBM2G 115 Series Dimensional Drawings

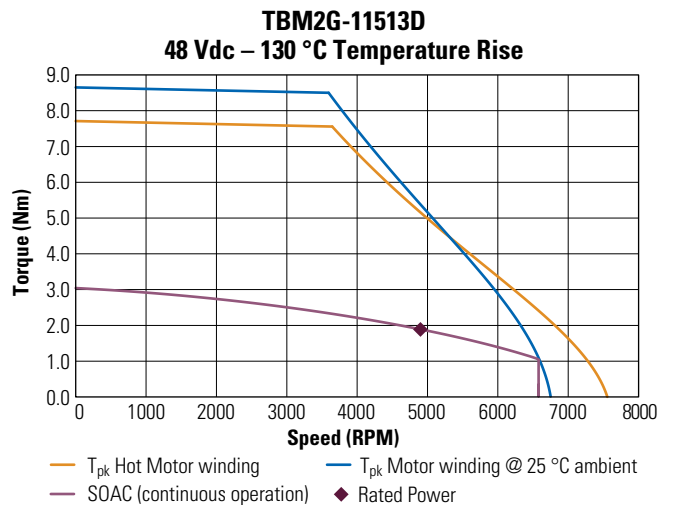
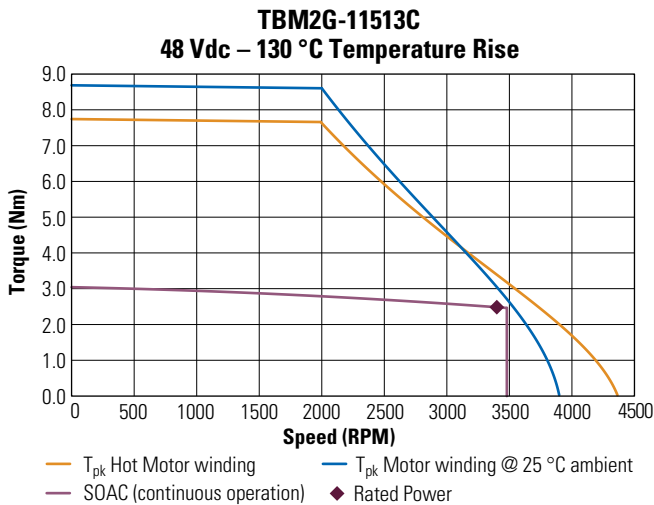
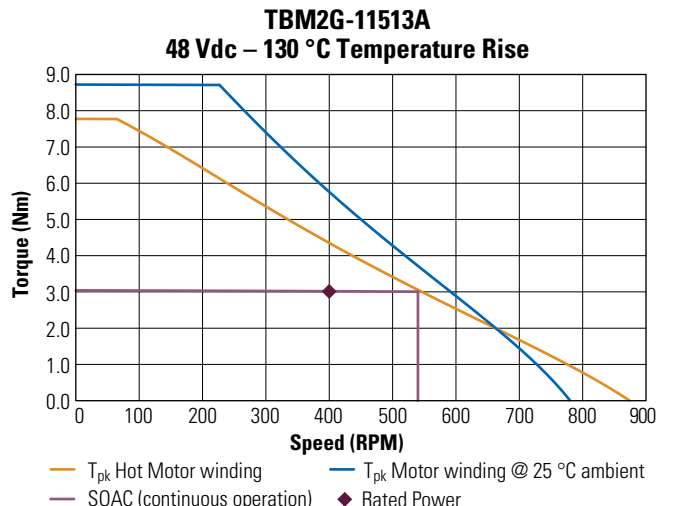
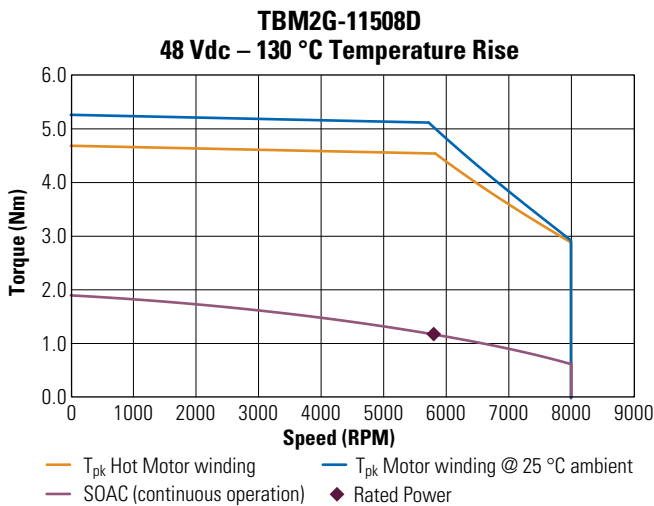
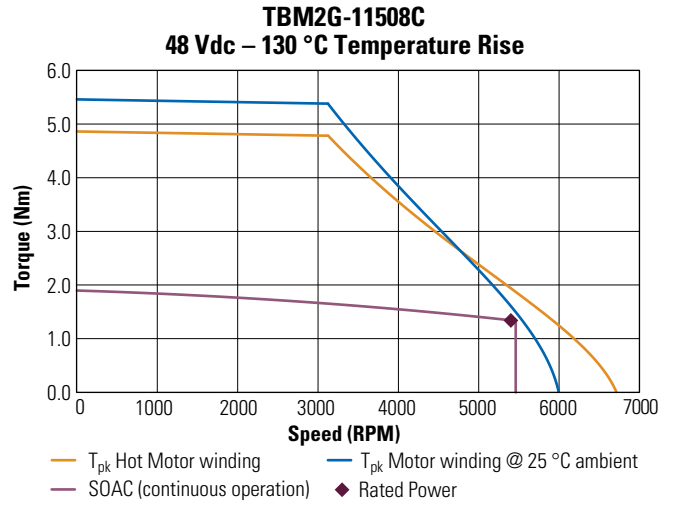
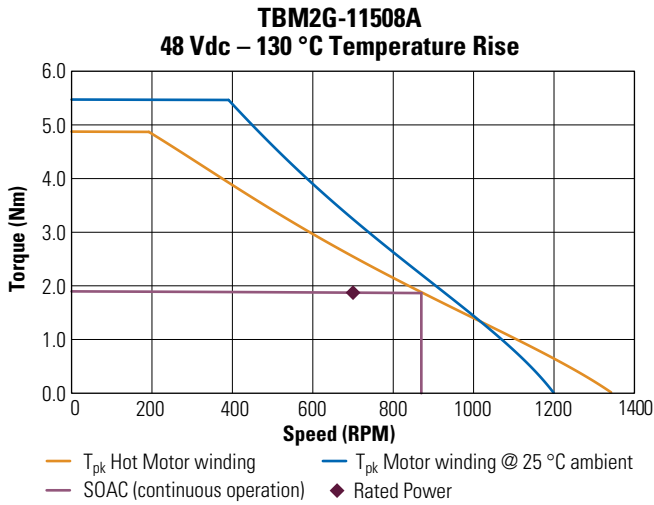

TBM2G 115 Series Performance Curves (Continued)

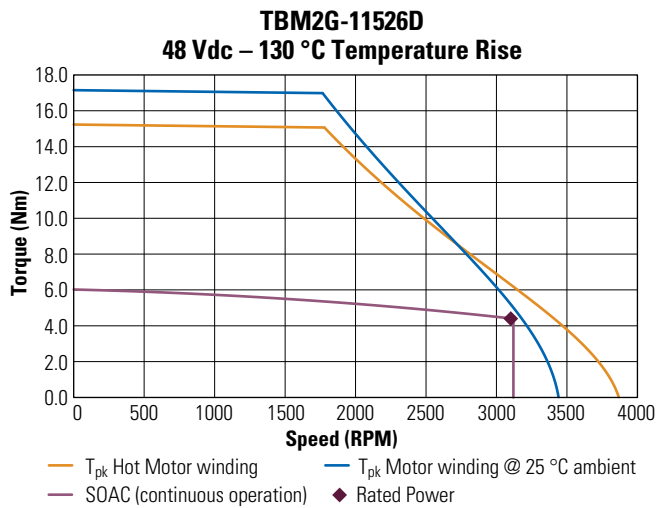
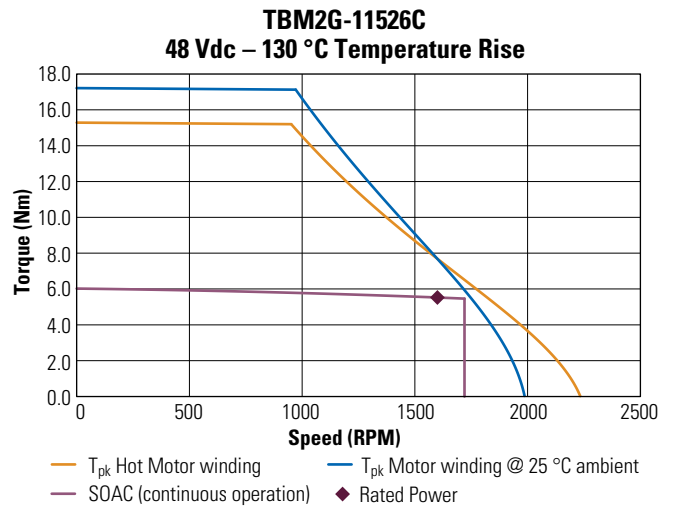
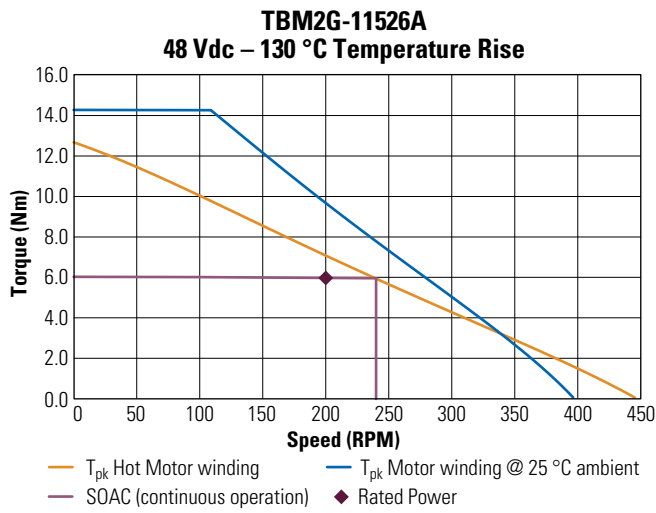

TBM2G 115 Series Motor

TBM2G 115 Series Dimensional Drawings

TBM2G-115

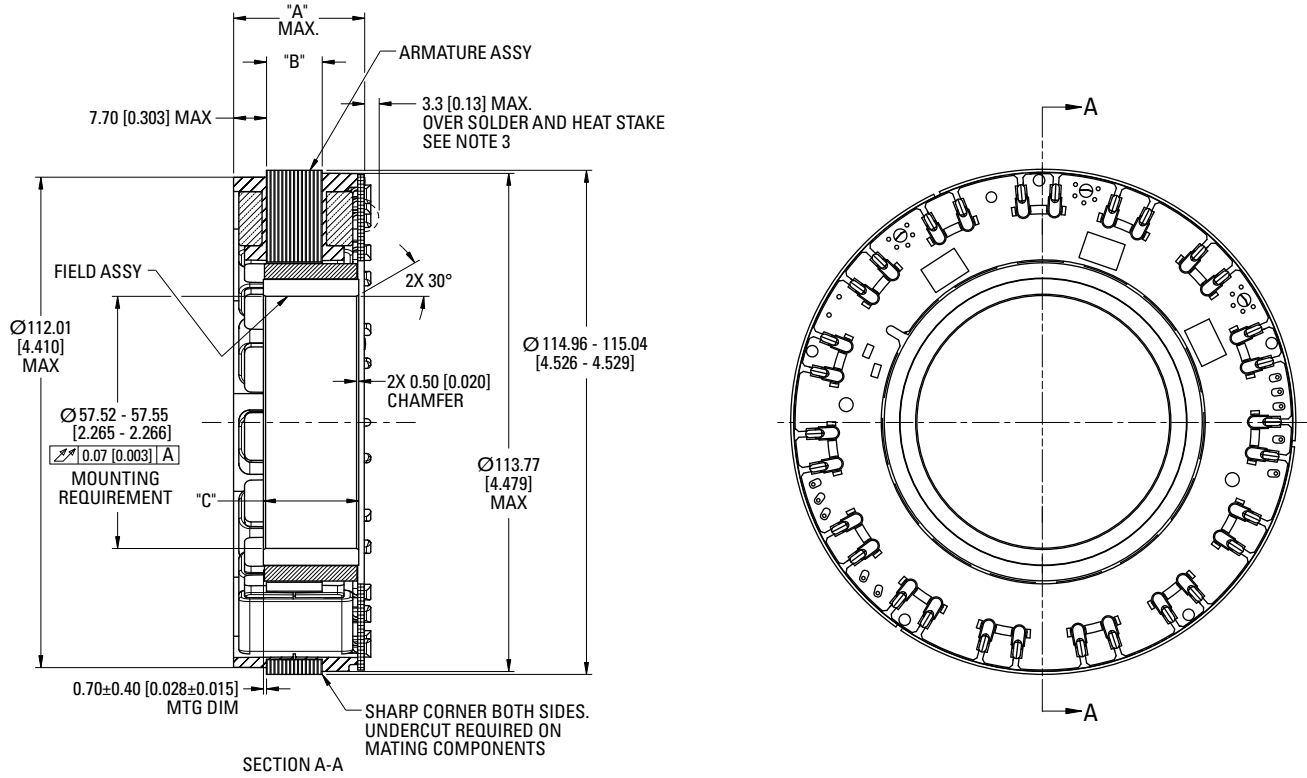

Stack Specific Dimensional Data

MODEL	"A" MAX.	"B" REF ±0.35 [0.014]	"C" ±0.08 [0.004]
TBM2G-11508	26.29 [1.035]	8.2 [0.323]	17.26 [0.679]
TBM2G-11513	30.79 [1.212]	12.70 [0.500]	21.67 [0.856]
TBM2G-11526	44.39 [1.747]	26.30 [1.035]	35.36 [1.392]

Notes:

1. All dimensions are in mm [inches] and are for reference only.
2. Motor supplied as two separate components: armature & sensor assembly and field assembly.
3. Customer must provide 0.25 [0.010] min. clearance from all solder and heat stakes.

TBM2G 115 Series Optional Leads Specifications

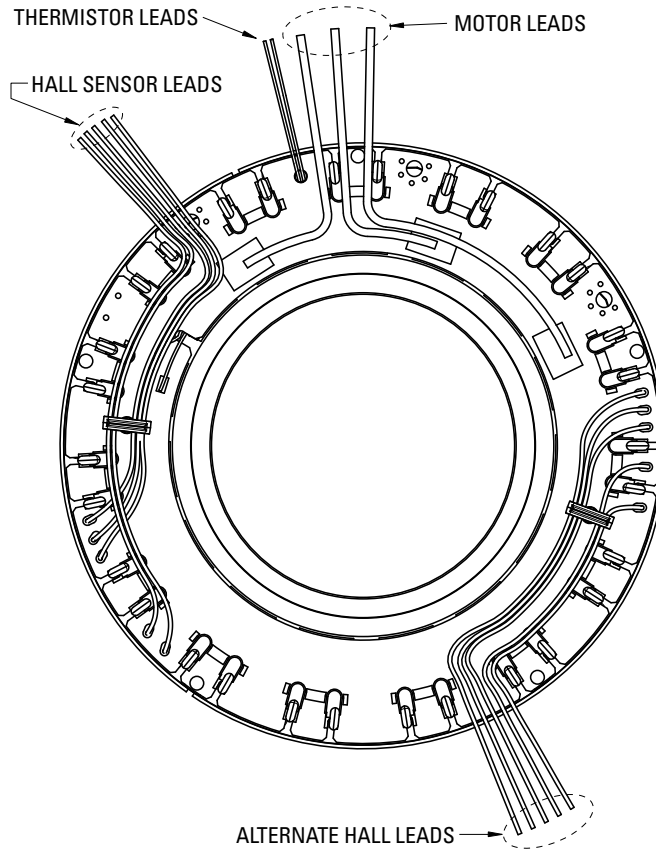

Motor Leads:

#14 AWG, ETFE Coated, Per UL Style 10086
 3 Leads, 0.5 m Length
 1 - Red, 1 - White, & 1 - Black
 Minimum Motor Lead Bend Radius 11.3 [0.445]

Hall Sensor Leads:

#26 AWG, ETFE Coated, Per UL Style 10086
 5 Leads, 0.5 m Length
 Minimum Lead Bend Radius 4.95 [0.195]

Thermistor Leads:

#26 AWG, ETFE Coated, Per UL Style 10086
 2 White Leads, 0.5 m Length
 Minimum Lead Bend Radius 4.95 [0.195]

Connection Options

PN Lead Designation	Lead Length (Min)
A	0.5 m
N	No leads

Sensor Options

PN Lead Designation	Lead Length (Min)
A	Hall Sensor Alternate Location
H	Hall Sensor
N	No Device

Thermal Device Options

PN Lead Designation	Lead Length (Min)
A	PT1000
B	3x PTC Devices
N	No Device

See Leads Connection Diagrams on page 52.

Leads Connection Diagrams

Excitation Sequence Table

Power Leads Excitation Chart			
STEP	Phase "U" Red	Phase "V" White	Phase "W" Black
1	⊕	⊖	
2	⊕		⊖
3		⊕	⊖
4	⊖	⊕	
5	⊖		⊕
6		⊖	⊕

CW rotation viewed from PCB/Lead Exit End

Hall Sensor Wiring Diagram

R = 1.5k Ohms (Customer Supplied)

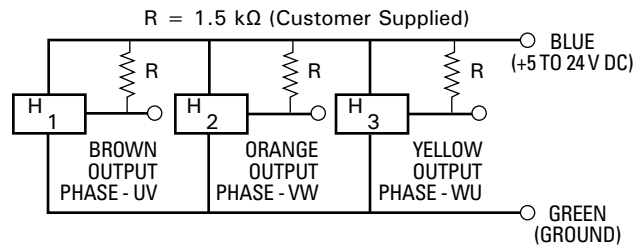

Hall Sensor Output

U, V, W phased CW rotation viewed at PCB/Lead Exit End

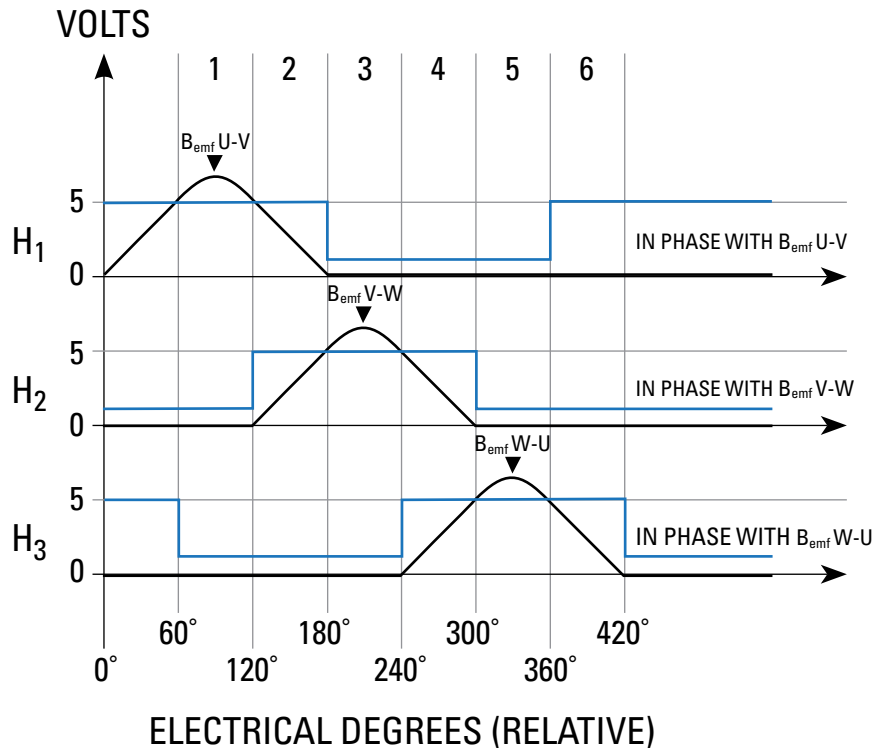

Thermal Sensor Protective Devices

To provide for continuous safe operation of series motors in demanding applications, integral thermistors may be attached to the PCBA. The typical option for is a PT1000 RTD. As an alternative, three PTC devices wired in series with one placed in each phase winding provides protection of each phase.

Thermal Device Options: Resistance vs. Temperature Graphs

Kollmorgen AKD drives can directly interpret information from the motor thermal sensors to properly reflect the motor winding temperature. For other drives please refer to the graph Delta Between Motor Winding and Thermal Device on the following page.

Option A

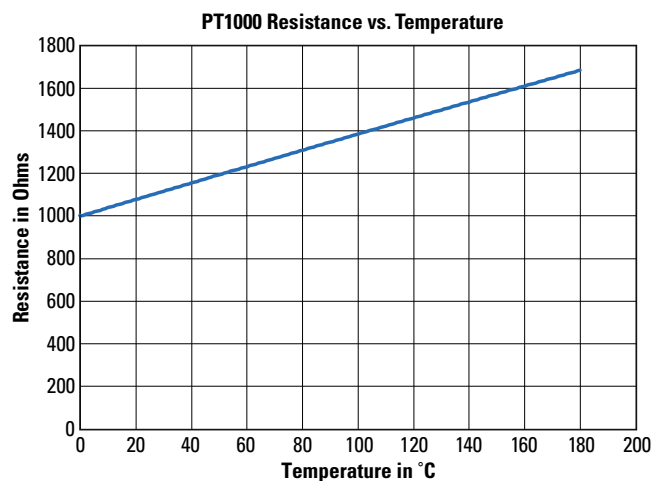

Option B

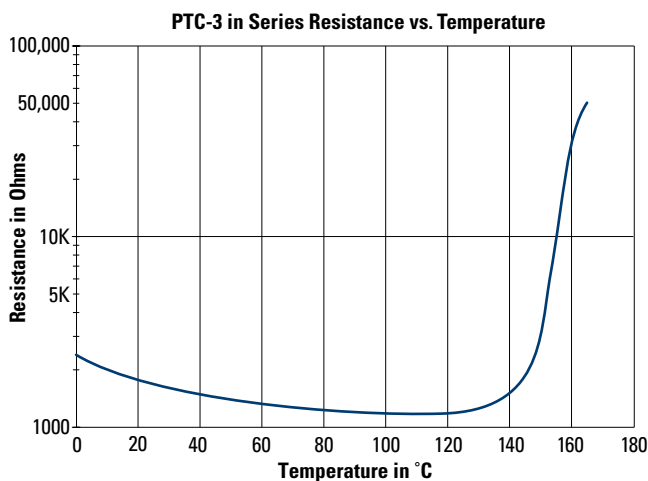

Note: This option has three PTC in series in three different phases. If one of the phases approaches the temperature rating of the motor, the resistance will greatly increase.



Notes

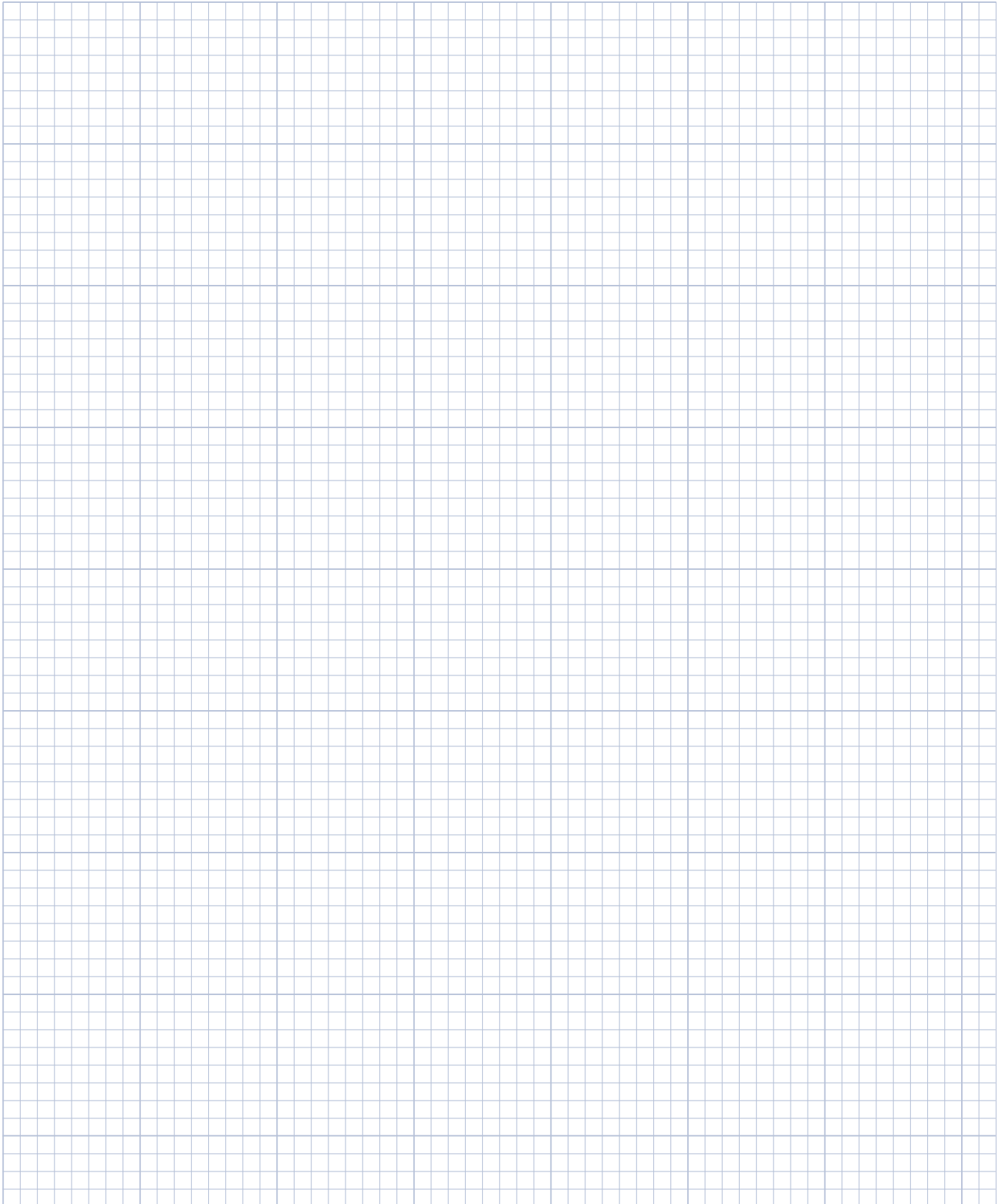

0.125 inch divisions

Kollmorgen Solutions

Automation and Motion Control

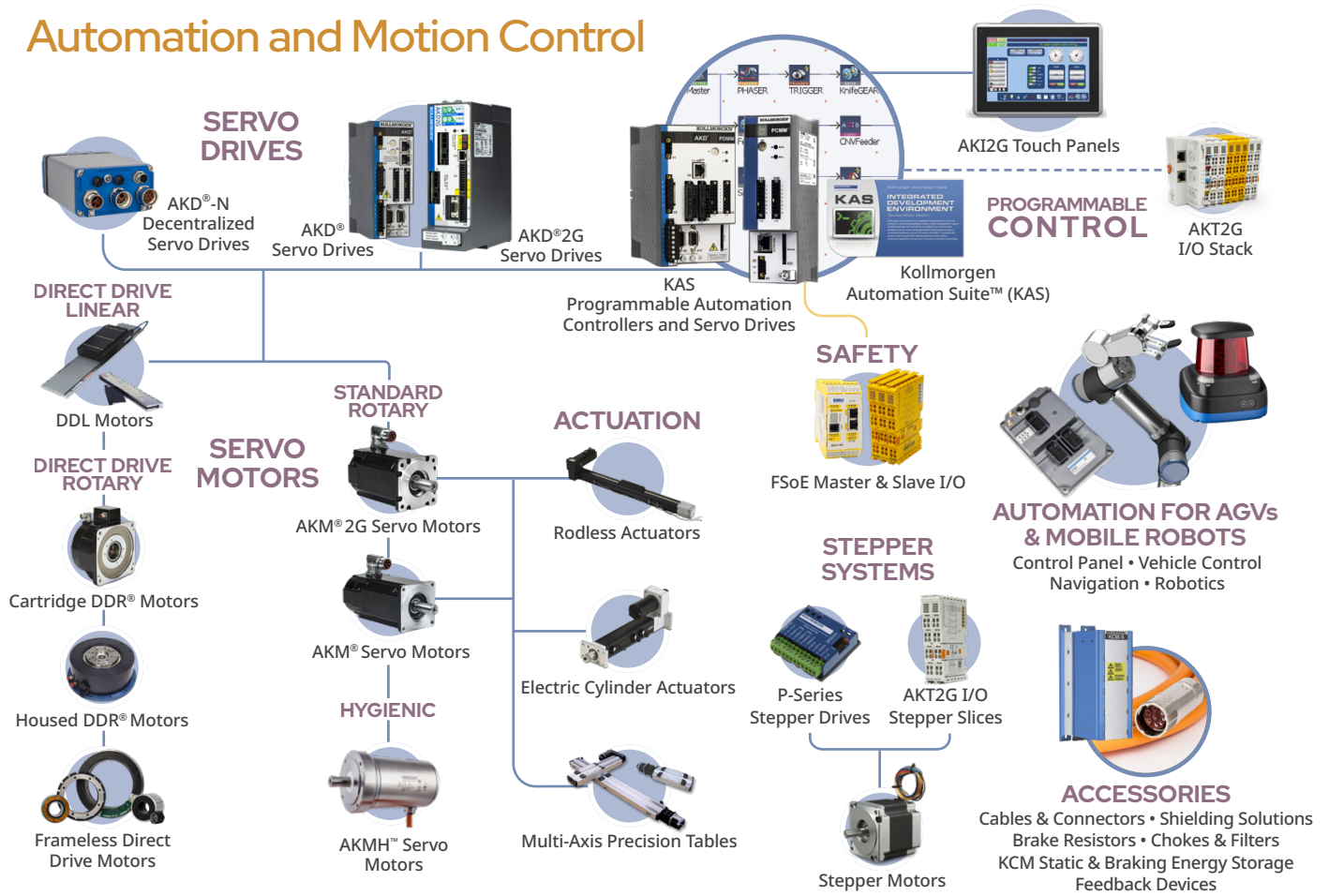

Self-Help Tools

Motioneering® Online

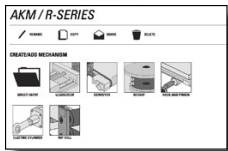

Size and select the right product for your application needs

Drawing Generator



Provides TBM/KBM/AKM 2D and 3D drawings in many popular formats

Performance Curve Generator

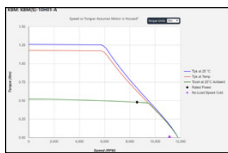

Optimize TBM/KBM/AKM windings using customer supplied environmental and drive information

Product Selector

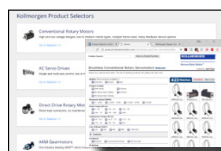

Choose the right product for your application needs

Kollmorgen Developer Network



Find answers to many key technical questions or start your own session

Stepper Optimizer

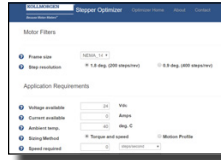

Select the most efficient stepper solution for your application

More Expertise for a More Successful Machine

Our global engineering, service and support network provides deep knowledge of all the major industries that rely on advanced motion control and automation technology. We offer world-class engineering expertise, self-service design tools, personalized field service, and easy access to our design, application and manufacturing centers in strategic locations across the globe.

About Kollmorgen

Kollmorgen has more than 70 years of motion experience, proven in the industry's highest-performing, most reliable motors, drives, linear actuators, gearheads, AGV control solutions and automation platforms. We deliver breakthrough solutions that are unmatched in performance, reliability and ease of use, giving machine builders an irrefutable marketplace advantage.

Kollmorgen is a brand of Altra Industrial Motion Corp. (NASDAQ: AIMC), a premier global designer and producer of a wide range of motion control and power transmission solutions. With engineered components and systems that provide the essential control of equipment speed, torque, positioning, and other functions, Altra products can be used in nearly any machine, process or application involving motion.

KOLLMORGEN

www.kollmorgen.com

Specifications are subject to change without notice. It is the responsibility of the product user to determine the suitability of this product for a specific application. All trademarks are the property of their respective owners

© 2022 Kollmorgen Corporation. All rights reserved