

AKM[®] 2G Low Voltage Servo Motor

Selection Guide

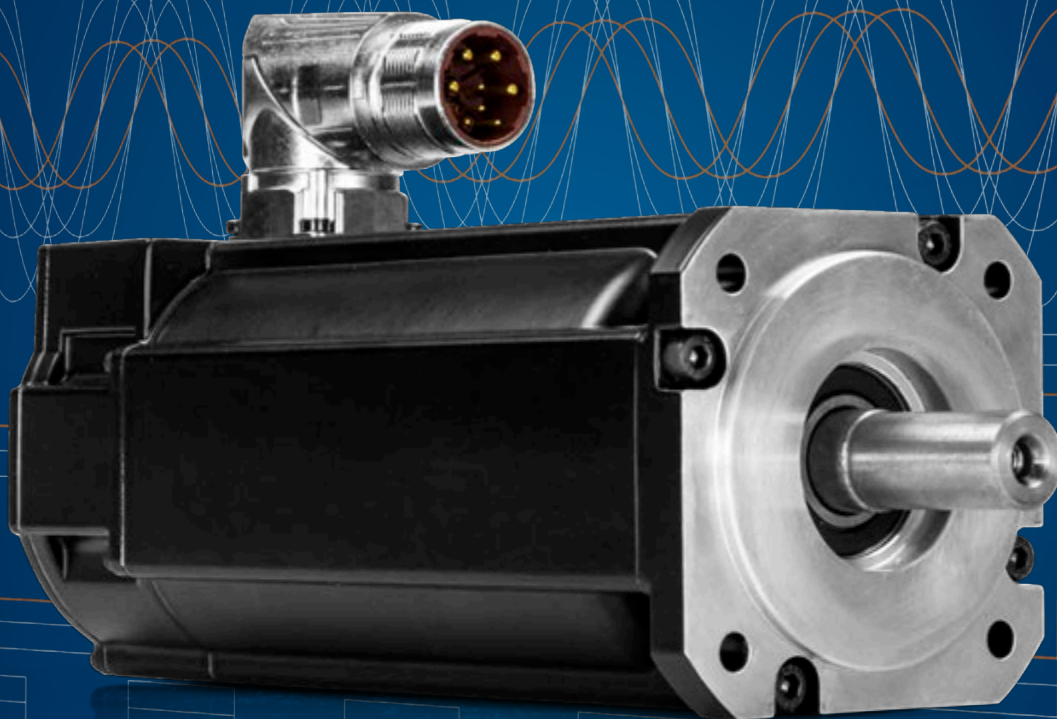

KOLLMORGEN

Kollmorgen: Your partner. In Motion.

Every solution comes from a real understanding of the challenges facing machine designers and users.

Innovators consistently rate Kollmorgen as one of their best motion systems manufacturing partners. Whether you are looking for classic servo motors, direct-drive servo motors, stepper motors, drives & amplifiers, gearing, actuation, or multi-axis motion controllers, Kollmorgen is one of the few companies in the world who actually designs and manufactures all of these products.

Our customers are leaders in many industries such as Aerospace & Defense, Printing, Packaging & Converting, Food & Beverage Processing, Medical Imaging, In Vitro Diagnostics & Laboratory Automation, Pharmaceutical Manufacturing, Material Forming and Cutting, Oil & Gas, and Robotics. Kollmorgen is also a leader in Warehouse Automation, including complete AGV systems, software, awareness and autonomy.

Our Automation Solutions can be found on Mars and in space, ships and submarines, O&G drilling and metrology, surgical robots and laser eye surgery, even inside artificial hearts. These are just a few applications that demand high-performance and high-quality while satisfying their specific needs.

Because motion matters, it's our focus: Motion can distinctly differentiate a machine and deliver a marketplace advantage by increasing its performance and dramatically improving overall equipment effectiveness (OEE).

High-performance motion can make your customer's machine more reliable and energy-efficient, enhance accuracy and improve operator safety. Motion also represents endless possibilities for innovation.

We've always understood this potential, and thus have kept motion at our core and in our Vision, Mission & Values, relentlessly developing products that offer precise control of torque, velocity and position accuracy in machines that rely on complex motion.

Removing the Barriers of Design, Sourcing, and Time

At Kollmorgen, we know that OEM engineers can achieve a lot more when obstacles aren't in the way. So, we clear obstacles in three important ways:

Integrating Standard and Custom Products

The optimal solution is often not clear-cut. Our application expertise allows us to modify standard products or develop totally custom solutions across our whole product portfolio so that designs can take flight.

Providing Motion Solutions, Not Just Components

As companies reduce their supplier base and have less engineering manpower, they need a total system supplier with a wide range of integrated solutions. Kollmorgen offers complete solutions as well as motion subsystems that combine programming software, engineering services and best-in-class motion components.

Global Footprint

With direct sales, engineering support, manufacturing facilities, and distributors spanning the Americas, Europe, the Middle East, and Asia, we're close to OEMs worldwide. Our proximity helps speed delivery and lend support where and when they're needed.

Financial and Operational Stability

Kollmorgen is part of Altra Industrial Motion. A key driver in the growth of all Altra divisions is the Altra Business System, which relies on the principle of "kaizen" – or continuous improvement. Using world-class tools, cross-disciplinary teams of exceptional people evaluate processes and develop plans that result in superior performance.

Kollmorgen: Your partner. In Motion.

Trademarks

AKD is a registered trademark of Kollmorgen Corporation
 AKM is a registered trademark of Kollmorgen Corporation
 EnDat is a registered trademark of Dr. Johannes Heidenhain GmbH
 EtherCAT is a registered trademark and patented technology, licensed by Beckhoff Automation GmbH
 Ethernet/IP is a registered trademark of ODVA, Inc.
 Ethernet/IP Communication Stack: copyright (c) 2009, Rockwell Automation
 sercos® is a registered trademark of sercos® international e.V.
 HIPERFACE and HIPERFACE DSL are registered trademarks of Max Stegmann GmbH
 PROFINET is a registered trademark of PROFIBUS and PROFINET International (PI)
 SIMATIC is a registered trademark of SIEMENS AG
 SpeedTec, ytec, itec and htec are registered trademarks of TE Connectivity Ltd.
 Windows is a registered trademark of Microsoft Corporation

Table of Contents

- ▶ **AKM Servo Motor Family** **4**
- ▶ **AKM2G Low Voltage Servo Motor Benefits** **5**
- ▶ **AKM2G Servo Motor Frame Sizes** **6**
- ▶ **AKM2G-2x Performance Data** **8**
 - Performance Data 8
 - Performance Curves 10
 - Dimensional Drawings 14
- ▶ **AKM2G-3x Performance Data** **16**
 - Performance Data 16
 - Performance Curves 18
 - Dimensional Drawings 20
- ▶ **AKM2G-4x Performance Data** **22**
 - Performance Data 22
 - Performance Curves 24
 - Dimensional Drawings 28
- ▶ **L10 Bearing Fatigue and Shaft Loading** **30**
- ▶ **Thermal Sensor Protective Devices** **32**
- ▶ **Brake Option** **34**
- ▶ **Feedback Options** **35**
- ▶ **Servo Motor Feedback Combinations** **36**
- ▶ **AKM2G Servo Motor Connector Pinouts** **38**
- ▶ **AKM2G Low Voltage Servo Motor Nomenclature** **41**
- ▶ **Kollmorgen Solutions** **43**
 - Automation and Motion Control 43
 - Self-help Tools 43

AKM[®] Servo Motor Family

Kollmorgen's AKM family of servo motors gives you unprecedented choice and flexibility from a wide range of standard products so you can select the best servo motor for your application.

From the Low Voltage motors in this Selection Guide to the broad range of AKM and AKM2G motors that support voltages up to 480 Vac, washdown, food grade, and the AKMH stainless steel hygienic motor for the toughest environments- Kollmorgen has a standard motor solution that can meet your needs right from the catalog.

Still need more? For your truly unique motion control applications, work with our engineering team to customize a solution for your machine design. Either way, standard product or customized, we can help you choose the motion control solution that meets your exact requirements.





The Benefits of AKM2G Low Voltage Servo Motors

Smaller footprint reduces machine space

- » For equivalent power it is possible to use a smaller size motor than competitive motors.
- » Use of the smaller motor saves space achieving equivalent performance in a smaller footprint machine or saving space for other machine elements.

Voltage options to match application needs

- » Standard voltage selections of 24, 48, 72 and 96 Vdc meet most available power sources
 - » Kollmorgen can work with you to meet your specific requirements for the exact solution you need.
-

Wider speed range provides faster operation

- » For many AKM2G sizes the maximum speeds are higher than competitive motors.
 - » Higher speeds ⇒ operate machines faster ⇒ greater throughput.
-

Greater flexibility provides more options to match needs

- » AKM2G is designed to support a wider array of feedback, brake, thermal sensor and shaft seal options – this greater flexibility means a higher probability of meeting application requirements with a standard product.
 - » The AKM2G design has the potential for greater CoEngineering (modification) thanks to the new housing design. With a more flexible design for CoEngineering addressing applications not covered by catalog standards is increased.
-

Higher efficiency reduces energy consumption

- » AKM2G has lower equivalent resistance than competitive solutions. For equivalent motor frame sizes AKM2G will typically be more energy efficient (2-5%).
- » Energy consumption is reduced with AKM2G compared to competitors.
- » When weight and space are critical such as on portable, mobile or battery power applications higher efficiency translates to a smaller motor with lower energy demand.

AKM[®] 2G Servo Motor Frame Sizes

AKM2G Low Voltage Motors are a part of the AKM2G Servo Motor family - the next generation of motion for more ambitious machines built on more capable performance and more confident engineering.



AKM2G-2x
Flange: 58 mm
Power: 0.206 - 1.16 kW
Max Speed: 8000 RPM
Stacks: 4

Available with Low Voltage Windings.



AKM2G-3x
Flange: 72 mm
Power: 0.175 - 1.77 kW
Max Speed: 8000 RPM
Stacks: 3

Available with Low Voltage Windings.



AKM2G-4x
Flange: 88 mm
Power: 0.267 - 2.85 kW
Max Speed: 6000 RPM
Stacks: 4

Available with Low Voltage Windings.



AKM2G-5x
Flange: 114 mm
Power: 0.78 - 5.28 kW
Max Speed: 6000 RPM
Stacks: 4



AKM2G-6x
Flange: 142 mm
Power: 1.56 - 7.79 kW
Max Speed: 6000 RPM
Stacks: 4



AKM2G-7x
Flange: 192 mm
Power: 2.42 - 11.8 kW
Max Speed: 6000 RPM
Stacks: 4



Looking for Traditional AC Voltage windings? To find performance specifications, outline drawings, 3D models and performance curves for AKM2G standard windings designed for 120 Vac to 480 Vac operation, please visit the AKM2G product page: kollmorgen.com/akm2g.

Notes

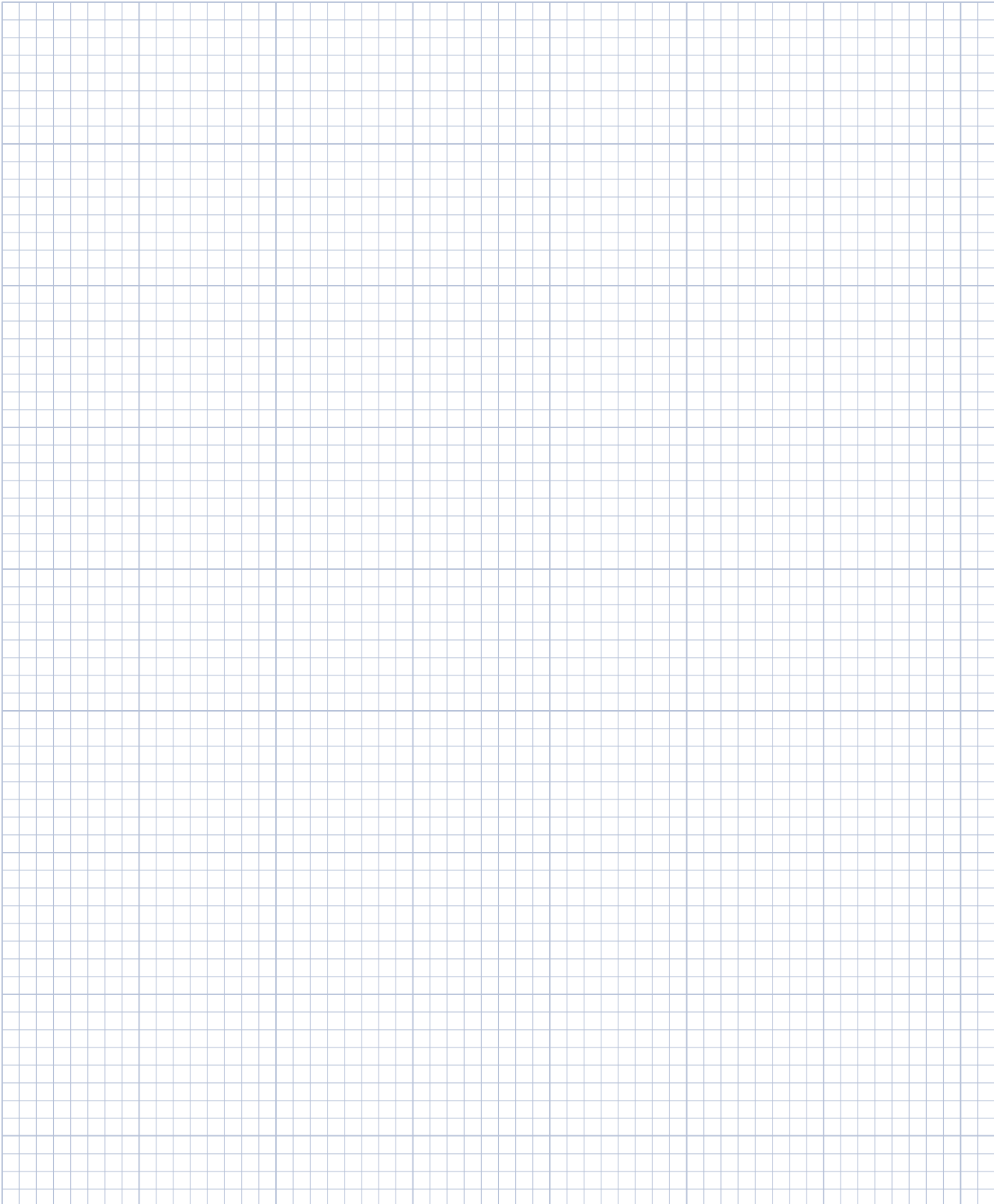

0.125 inch divisions

AKM2G-2x Performance Data

AKM2G-2x Low Voltage Servo Motor Performance Data – Up to 96 Vdc voltage

Parameters	Tol	Symbol	Units	AKM2G-21			AKM2G-22			AKM2G-23			AKM2G-24		
				KL	ML	PL	KL	NL	PL	KL	ML	PL	KL	ML	PL
Max Rated Equivalent Line Voltage	Max	Vbus	Vdc	170	170	170	170	170	170	170	170	170	170	170	170
Max Continuous Torque for ΔT winding = 100°C ①②③	Nom	T _{cs}	Nm	0.640	0.642	0.642	1.10	1.11	1.12	1.48	1.49	1.50	1.79	1.79	1.82
			lb-in	5.66	5.68	5.68	9.76	9.85	9.92	13.1	13.2	13.3	15.9	15.9	16.1
Continuous Current for ΔT winding = 100°C ①②③	Nom	I _{cs}	A _{rms}	9.87	14.2	19.7	9.83	15.2	18.9	9.82	13.5	19.2	9.92	13.7	19.1
Max Continuous Torque for ΔT winding = 60°C ②③	Nom	T _{cs}	Nm	0.497	0.498	0.498	0.855	0.863	0.871	1.15	1.15	1.17	1.39	1.39	1.41
			lb-in	4.39	4.41	4.41	7.57	7.64	7.70	10.1	10.2	10.3	12.3	12.3	12.5
Max Mechanical Speed ④	Nom	N _{max}	rpm	8000	8000	8000	8000	8000	8000	8000	8000	8000	8000	8000	8000
Peak Torque ①②③	Nom	T _p	Nm	1.78	1.79	1.79	3.32	3.34	3.35	4.69	4.70	4.73	5.92	5.92	5.97
			lb-in	15.8	15.8	15.8	29.4	29.5	29.6	41.5	41.6	41.9	52.4	52.3	52.8
Peak Current	Nom	I _p	A _{rms}	39.5	56.8	78.6	39.3	60.8	75.6	39.3	54.0	76.9	39.7	54.9	76.4
Rated Torque (speed) ①②③		T _{rtd}	Nm	-	0.605	0.587	-	1.08	1.08	-	-	1.46	-	-	1.77
			lb-in	-	5.35	5.20	-	9.59	9.55	-	-	12.9	-	-	15.7
Rated Speed		N _{rtd}	rpm	-	3400	4700	-	2200	2900	-	-	1900	-	-	1600
Rated Power (speed) ①②③		P _{rtd}	kW	-	0.215	0.289	-	0.250	0.328	-	-	0.291	-	-	0.297
			Hp	-	0.289	0.388	-	0.335	0.439	-	-	0.390	-	-	0.399
Rated Torque (speed) ①②③		T _{rtd}	Nm	0.574	0.539	0.534	1.05	1.02	0.997	1.42	1.40	1.35	1.73	1.69	1.65
			lb-in	5.08	4.77	4.73	9.31	9.02	8.82	12.6	12.4	12.0	15.3	15.0	14.6
Rated Speed		N _{rtd}	rpm	5600	8000	8000	3300	5200	6400	2400	3400	4900	2000	2900	4000
Rated Power (speed) ①②③		P _{rtd}	kW	0.337	0.452	0.45	0.363	0.555	0.67	0.358	0.498	0.694	0.363	0.514	0.692
			Hp	0.451	0.606	0.600	0.487	0.744	0.896	0.480	0.668	0.930	0.487	0.689	0.928
Rated Torque (speed) ①②③		T _{rtd}	Nm	0.537	-	-	1.01	0.944	0.942	1.37	1.31	1.18	1.67	1.58	1.46
			lb-in	4.76	-	-	8.92	8.35	8.33	12.1	11.6	10.4	14.8	14.0	12.9
Rated Speed		N _{rtd}	rpm	8000	-	-	5300	8000	8000	4000	5500	8000	3300	4700	6500
Rated Power (speed) ①②③		P _{rtd}	kW	0.450	-	-	0.559	0.791	0.789	0.574	0.755	0.989	0.578	0.779	0.994
			Hp	0.604	-	-	0.750	1.06	1.06	0.770	1.01	1.33	0.775	1.05	1.33
Rated Torque (speed) ①②③		T _{rtd}	Nm	0.533	-	-	0.956	-	-	1.30	1.19	-	1.59	1.44	1.30
			lb-in	4.71	-	-	8.46	-	-	11.5	10.6	-	14.1	12.8	11.5
Rated Speed		N _{rtd}	rpm	8000	-	-	7300	-	-	5500	7600	-	4600	6500	8000
Rated Power (speed) ①②③		P _{rtd}	kW	0.446	-	-	0.731	-	-	0.751	0.951	-	0.766	0.982	1.085
			Hp	0.598	-	-	0.980	-	-	1.01	1.27	-	1.03	1.32	1.46

Notes:

- ① Motor winding temperature rise, $\Delta T = 100^\circ \text{C}$, at 40°C ambient.
- ② All data referenced to sinusoidal commutation.
- ③ Motor with standard feedback and standard heat sink.
- ④ May be limited at some values of Vbus.

AKM2G-2x Low Voltage Servo Motor Performance Data – Up to 96 Vdc voltage (continued)

Parameters	Tol	Symbol	Units	AKM2G-21			AKM2G-22			AKM2G-23			AKM2G-23		
				KL	ML	PL	KL	NL	PL	KL	ML	PL	KL	ML	PL
Torque Constant ①	±10%	K _t	Nm/A _{rms}	0.0655	0.0457	0.0330	0.113	0.0740	0.0599	0.152	0.111	0.0789	0.183	0.132	0.0962
			lb-in/A _{rms}	0.580	0.405	0.292	1.00	0.655	0.530	1.35	0.985	0.698	1.62	1.169	0.852
Back EMF Constant ②	±10%	K _e	V _{rms} /k _r rpm	4.31	3.01	2.17	7.41	4.84	3.92	9.88	7.23	5.12	11.81	8.52	6.21
Motor Constant ⑥	Nom	K _m	N-m/√W	0.0899	0.0902	0.0902	0.143	0.145	0.146	0.186	0.188	0.190	0.223	0.224	0.227
			lb-in/√W	0.796	0.798	0.798	1.27	1.28	1.29	1.65	1.66	1.68	1.98	1.98	2.01
Resistance (line-line) ②	±10%	R _m	Ohm	0.354	0.171	0.089	0.416	0.174	0.112	0.444	0.234	0.115	0.448	0.233	0.120
Inductance Q-Axis (line-line)		L _{qll}	mH	0.79	0.39	0.20	1.06	0.45	0.30	1.22	0.65	0.33	1.28	0.66	0.35
Inductance D-Axis (line-line)		L _{dll}	mH	TBD	TBD	TBD	TBD	TBD	TBD	TBD	TBD	TBD	TBD	TBD	TBD
Inductance Saturation Current		Lisat	Arms	69	99	137	79	121	150	89	121	171	99	137	188
Maximum Demagnetization Current		Midpeak	Arms	TBD	TBD	TBD	TBD	TBD	TBD	TBD	TBD	TBD	TBD	TBD	TBD
Inertia (includes feedback) ③	±10%	J _m	kg-cm ²	0.093			0.155			0.217			0.279		
			lb-in-s ²	8.23E-05			1.37E-04			1.92E-04			2.47E-04		
Optional Brake Inertia (additional)	±10%	J _m	kg-cm ²	0.040			0.040			0.040			0.040		
			lb-in-s ²	3.54E-05			3.54E-05			3.54E-05			3.54E-05		
Weight without brake ④		W	kg	1.1			1.4			1.7			2.0		
			lb	2.4			3.1			3.7			4.4		
Static Friction ①⑤		T _f	Nm	0.006			0.011			0.015			0.019		
			lb-in	0.05			0.10			0.13			0.17		
Viscous Damping ①		K _{dv}	Nm/k _r rpm	0.0015			0.0030			0.0045			0.0060		
			lb-in/k _r rpm	0.013			0.027			0.040			0.053		
Thermal Time Constant		TCT	minutes	9.6			10.8			11.9			13.0		
Coil Thermal Time Constant		MCT _{f0}		TBD			TBD			TBD			TBD		
Thermal Resistance ①		R _{thw-a}	K/W	1.33			1.14			1.07			1.04		
Pole Pairs		PP		3			3			3			3		
Heat Sink Size				10"x10"x1/4" Aluminum Plate			10"x10"x1/4" Aluminum Plate			10"x10"x1/4" Aluminum Plate			10"x10"x1/4" Aluminum Plate		

Notes:

① Motor winding temperature rise, ΔT = 100° C, at 40° C ambient.

② Measured at 25° C.

③ Add parking brake if applicable for total inertia.

④ Brake motor adds 0.45 kg [1.0 lbs]

⑤ Shaft seal increases Static Friction by 0.020 Nm [0.18 lb-in]

⑥ This value is calculated from the Torque Constant and Resistance. Refer to those values and notes ① & ② for additional details.

*Complete AKM2G-2 low voltage servo motor series model nomenclature can be found on page 41.

AKM2G-2x Performance Curves

AKM2G-2x Low Voltage Servo Motor Performance Data – Up to 96 Vdc voltage

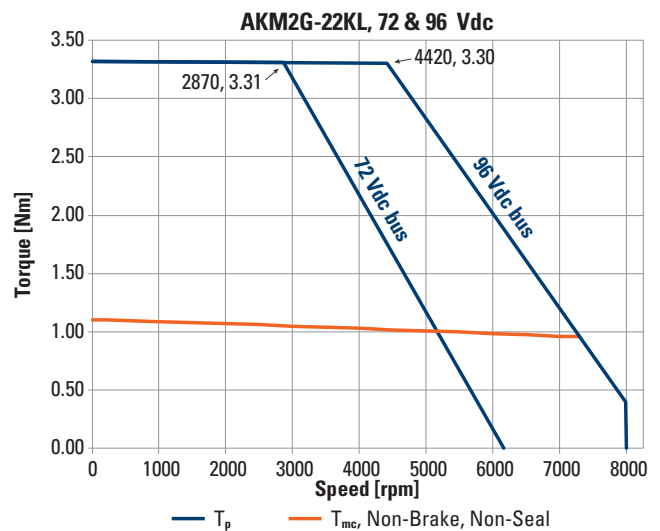
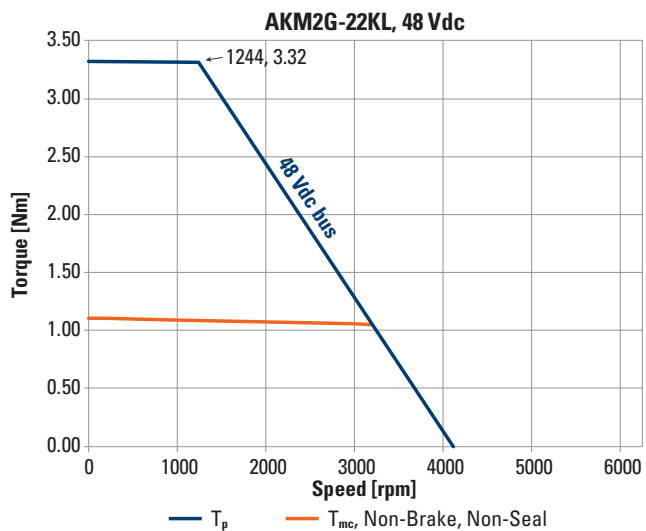
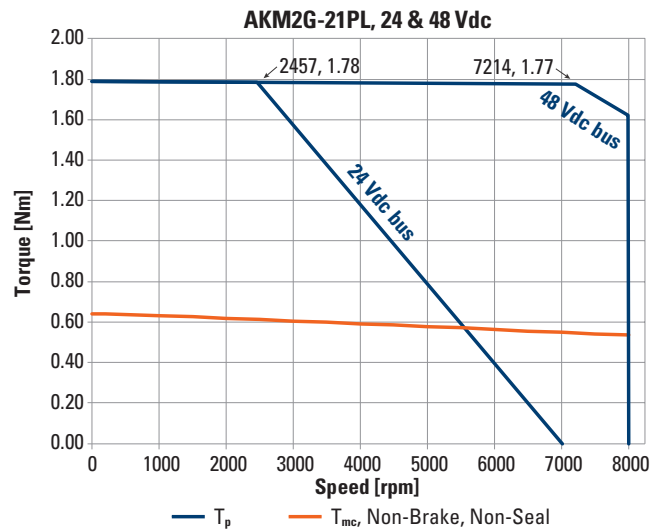
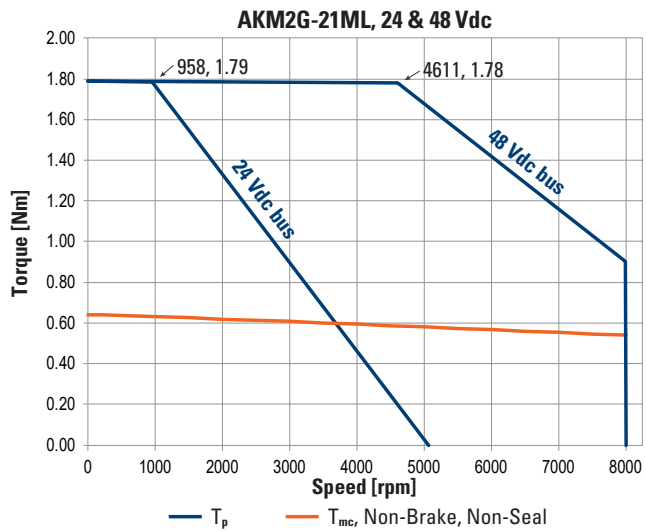
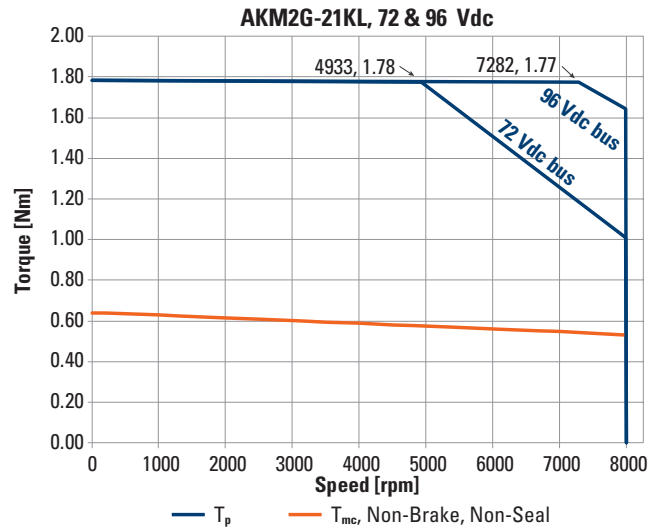
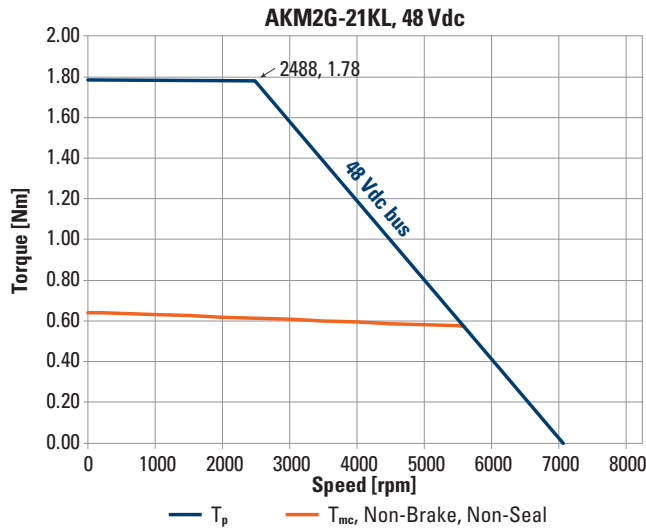

T_p = Peak torque
 T_{mc} = Maximum continuous torque
 Refer to page 40 for torque-speed curve properties.

AKM2G-2x Low Voltage Servo Motor Performance Data – Up to 96 Vdc voltage (continued)

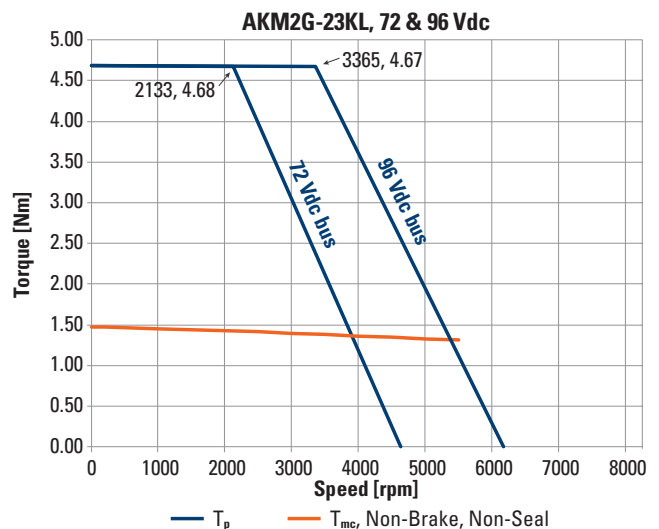
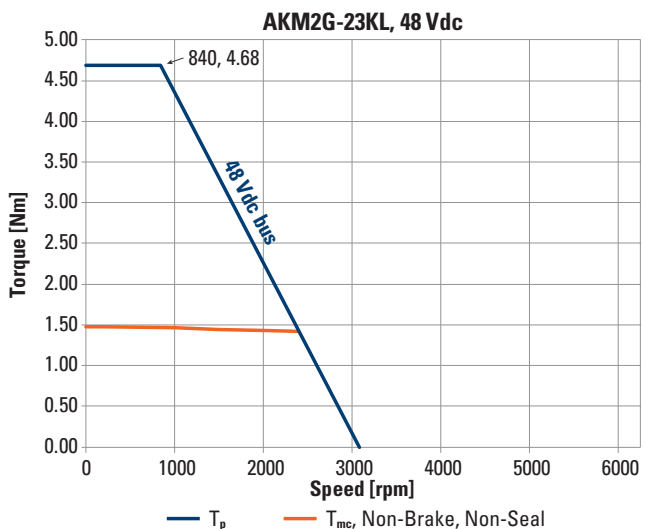
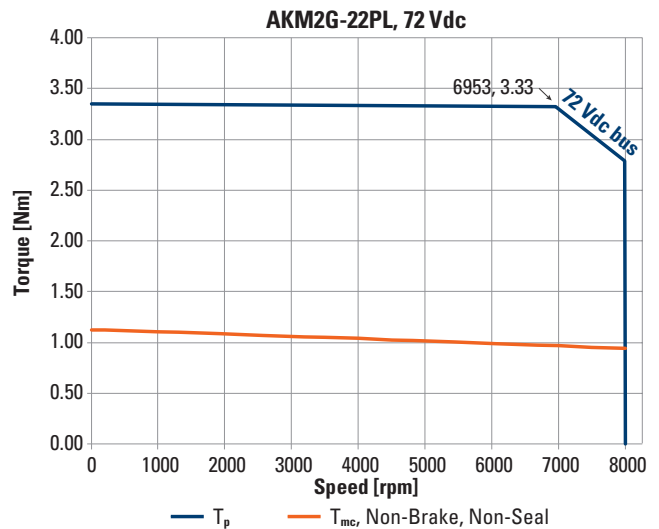
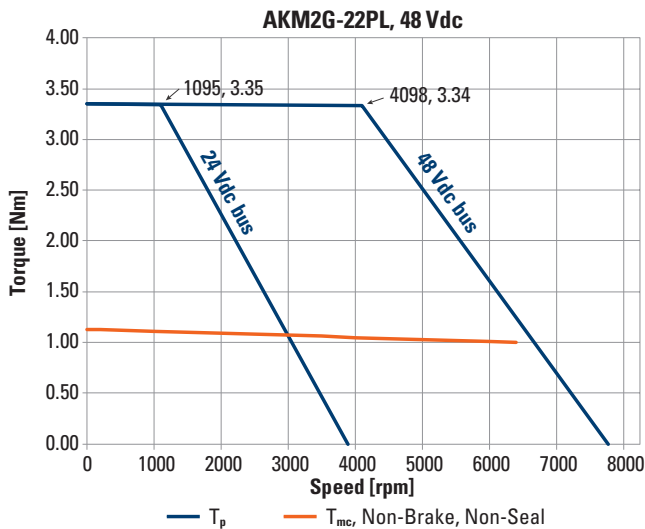
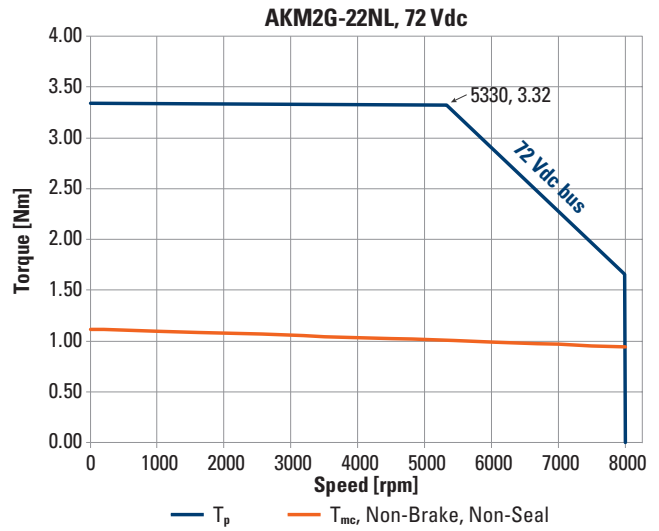
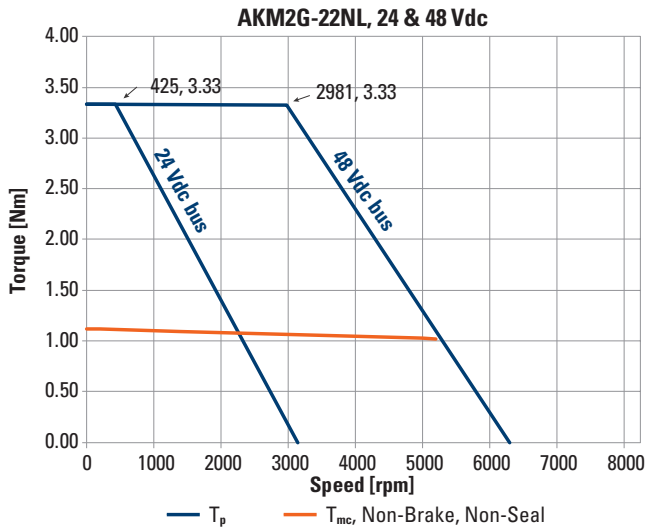

T_p = Peak torque
 T_{mc} = Maximum continuous torque
 Refer to page 40 for torque-speed curve properties.

AKM2G-2x Performance Curves

AKM2G-2x Low Voltage Servo Motor Performance Data – Up to 96 Vdc voltage (continued)

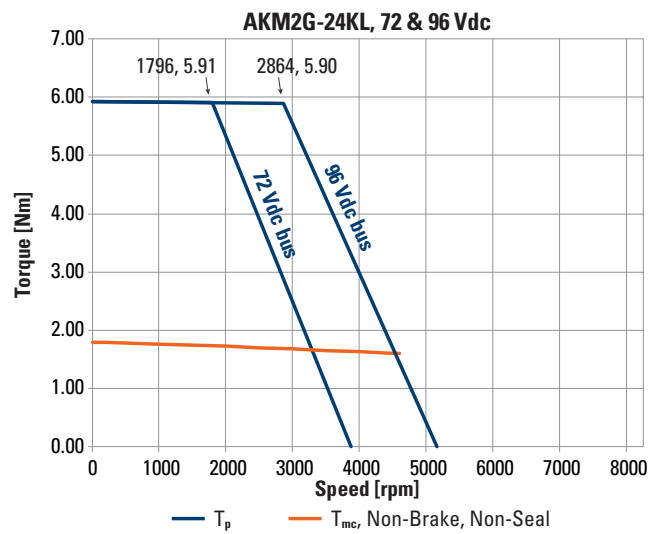
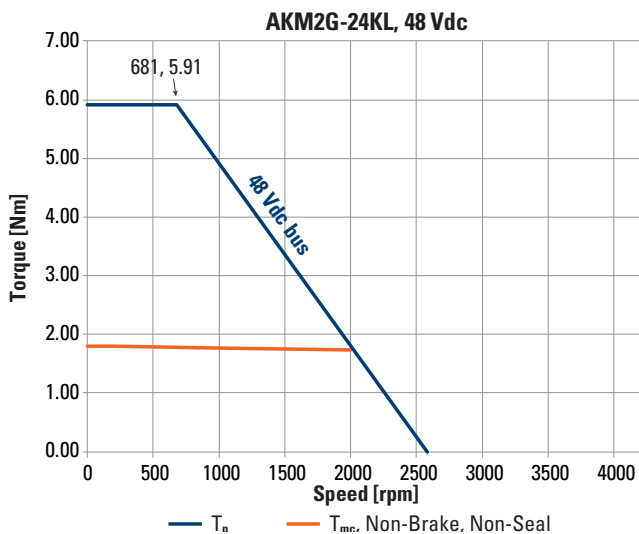
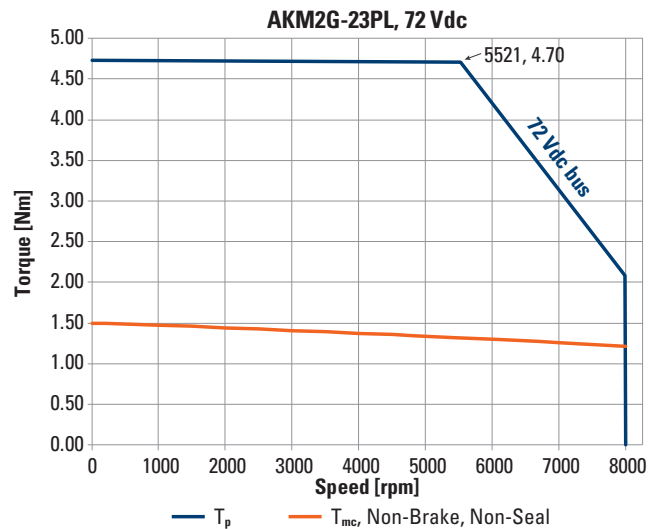
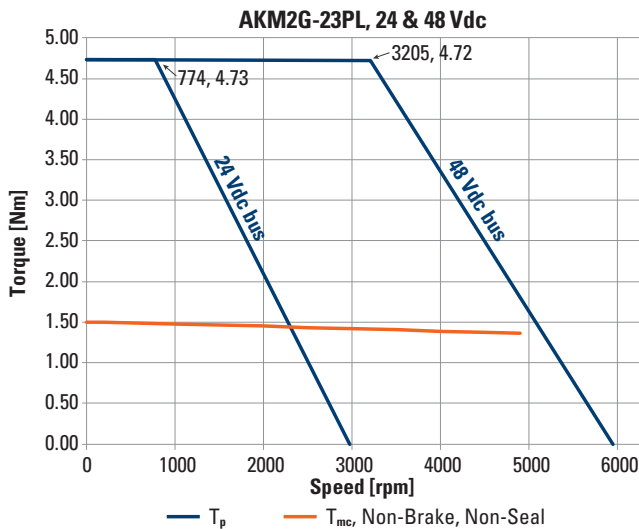
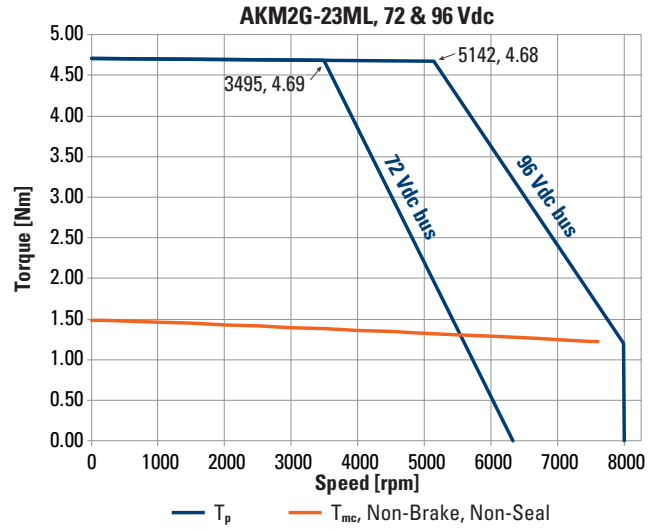
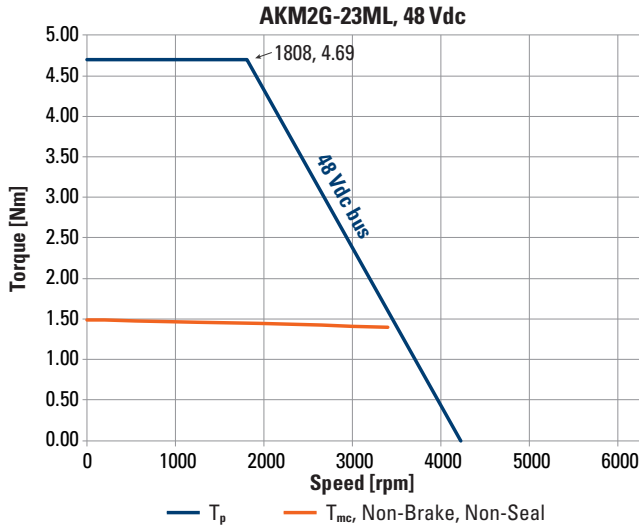

T_p = Peak torque
 T_{mc} = Maximum continuous torque
 Refer to page 40 for torque-speed properties.

AKM2G-2x Low Voltage Servo Motor Performance Data – Up to 96 Vdc voltage (continued)

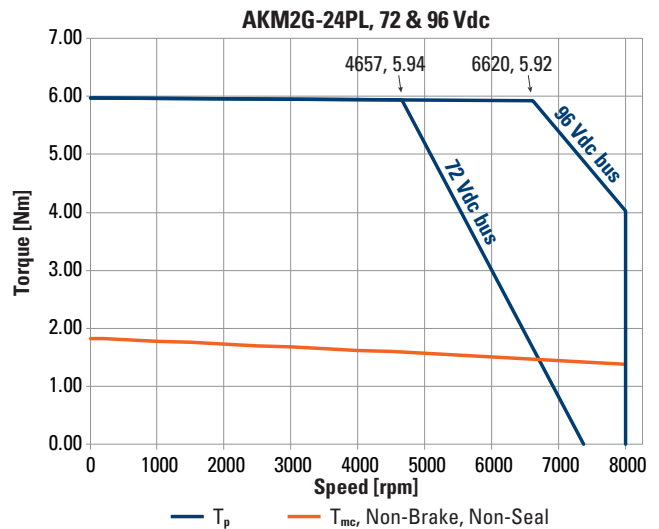
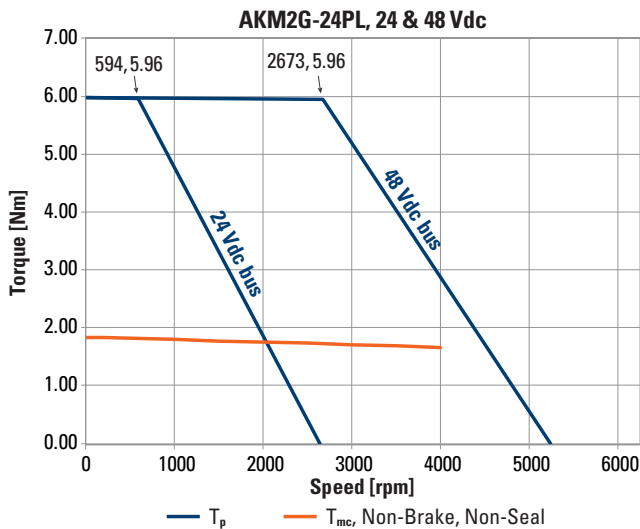
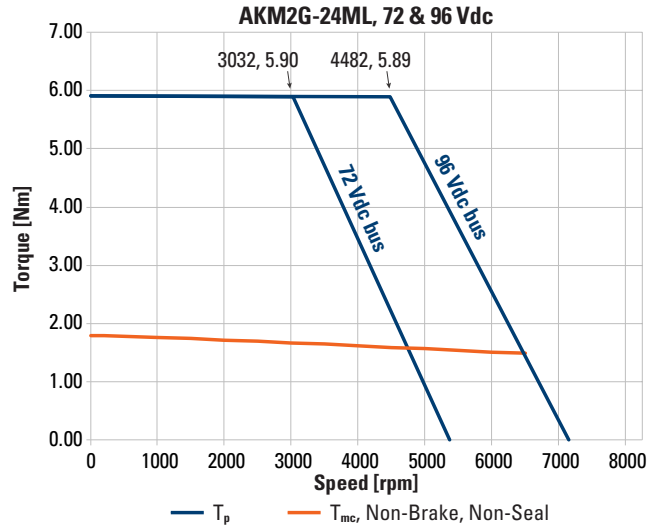
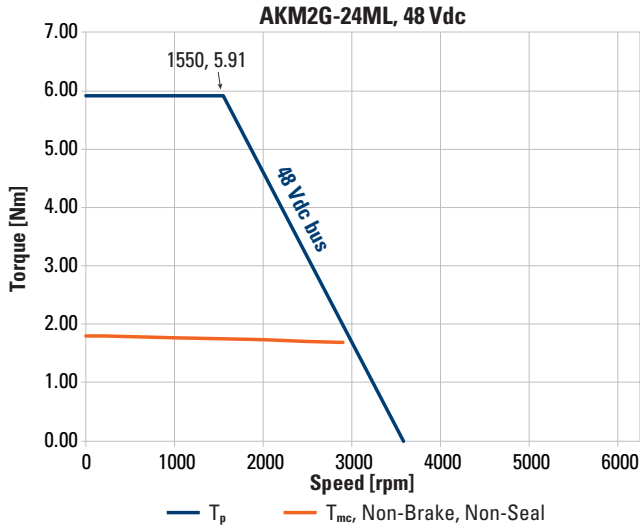

T_p = Peak torque
 T_{mc} = Maximum continuous torque
 Refer to page 40 for torque-speed curve properties.

AKM2G-2x Dimensional Drawings

AKM2G-2x Single Connector Frame

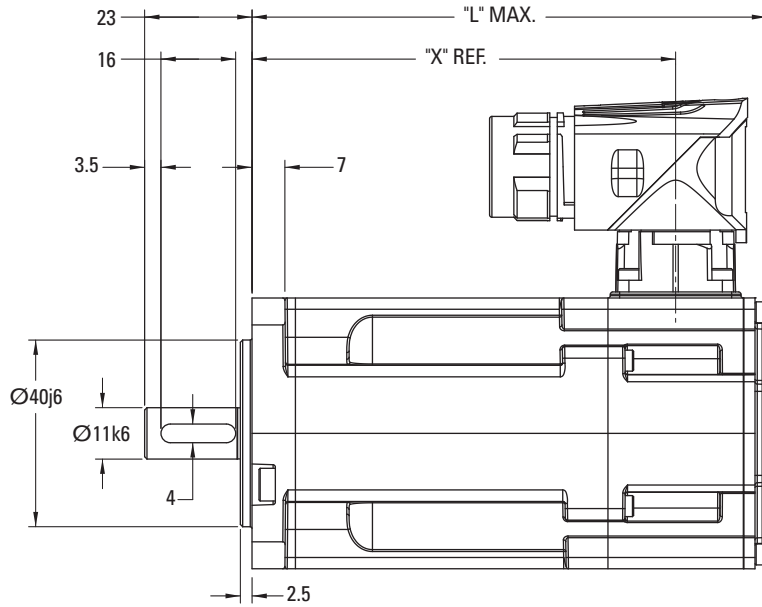

Pinout for illustration only. Refer to page 39 for specific pin-out based on feedback used.

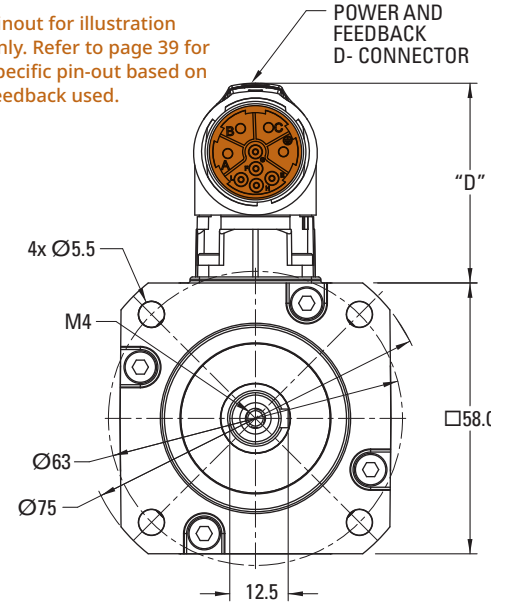

D- Connector Feedback	"D"
DSL & EnDat	42.8

AKM2G-2x "X" and "L" Dimensions

Model	No Brake		Model	Brake	
	X	DSL / EnDat 2.2 L		X	DSL / EnDat 2.2 L
AKM2G-21L	90.75	118.15	AKM2G-21L	129.75	157.15
AKM2G-22L	110	137.4	AKM2G-22L	149	176.4
AKM2G-23L	129.25	156.65	AKM2G-23L	168.25	195.65
AKM2G-24L	148.5	175.9	AKM2G-24L	187.5	214.9

Notes

AKM2G - Motor Series
2 - Frame Size
1 - Rotor Length
ML - Winding
AN - Shaft Flange
D - Connection
N - Brake
LD - Feedback
10 - Customization Thermal Sensor

0.125 inch divisions

AKM2G-3x Performance Data

AKM2G-3x Low Voltage Servo Motor Performance Data – Up to 96 Vdc voltage

Parameters	Tol	Symbol	Units	AKM2G-31		AKM2G-32		AKM2G-33	
				ML	PL	ML	PL	ML	PL
Max Rated Equivalent Line Voltage	Max	Vbus	Vdc	170	170	170	170	170	170
Max Continuous Torque for ΔT winding = 100°C ①②③	Nom	T_{CS}	Nm	1.73	1.69	2.89	2.77	3.82	3.83
			Ib-in	15.3	15.0	25.6	24.6	33.8	33.9
Continuous Current for ΔT winding = 100°C ①②③	Nom	I_{CS}	A_{RMS}	14.2	20.0	14.8	20.0	14.8	20.0
Max Continuous Torque for ΔT winding = 60°C ②③	Nom	T_{CS}	Nm	1.34	1.33	2.25	2.23	2.97	3.01
			Ib-in	11.9	11.8	19.9	19.7	26.3	26.7
Max Mechanical Speed ④	Nom	N_{max}	rpm	8000	8000	8000	8000	8000	8000
Peak Torque ①②③	Nom	T_p	Nm	6.14	6.09	10.7	10.6	14.5	14.6
			Ib-in	54.3	53.9	94.6	93.7	128	130
Peak Current	Nom	I_p	A_{RMS}	56.8	80.7	59.1	82.4	59.0	80.8
Rated Torque (speed) ①②③		T_{rtd}	Nm	-	1.67	-	2.79	-	3.82
			Ib-in	-	14.8	-	24.7	-	33.8
Rated Speed		N_{rtd}	rpm	-	2200	-	1300	-	800
Rated Power (speed) ①②③		P_{rtd}	kW	-	0.385	-	0.379	-	0.320
			Hp	-	0.517	-	0.509	-	0.430
Rated Torque (speed) ①②③		T_{rtd}	Nm	1.65	1.57	2.81	2.70	3.69	3.64
			Ib-in	14.6	13.9	24.9	23.9	32.6	32.2
Rated Speed		N_{rtd}	rpm	3300	4900	2000	3000	1500	2100
Rated Power (speed) ①②③		P_{rtd}	kW	0.570	0.804	0.589	0.849	0.579	0.801
			Hp	0.764	1.08	0.790	1.138	0.777	1.07
Rated Torque (speed) ①②③		T_{rtd}	Nm	1.57	1.41	2.70	2.51	3.54	3.38
			Ib-in	13.9	12.4	23.9	22.2	31.3	30.0
Rated Speed		N_{rtd}	rpm	5200	7800	3200	4700	2400	3400
Rated Power (speed) ①②③		P_{rtd}	kW	0.853	1.15	0.906	1.23	0.890	1.21
			Hp	1.14	1.54	1.215	1.66	1.19	1.62
Rated Torque (speed) ①②③		T_{rtd}	Nm	1.46	-	2.57	2.26	3.34	3.06
			Ib-in	12.9	-	22.7	20.0	29.6	27.1
Rated Speed		N_{rtd}	rpm	7200	-	4400	6400	3400	4700
Rated Power (speed) ①②③		P_{rtd}	kW	1.10	-	1.18	1.51	1.19	1.50
			Hp	1.47	-	1.59	2.03	1.60	2.02

Notes:

- ① Motor winding temperature rise, $\Delta T = 100^\circ C$, at $40^\circ C$ ambient.
- ② All data referenced to sinusoidal commutation.
- ③ Motor with resolver feedback and standard heat sink.
- ④ May be limited at some values of Vbus.

AKM2G-3x Low Voltage Servo Motor Performance Data – Up to 96 Vdc voltage (continued)

Parameters	Tol	Symbol	Units	AKM2G-31		AKM2G-32		AKM2G-33	
				ML	PL	ML	PL	ML	PL
Torque Constant ①	±10%	K _t	Nm/A _{rms}	0.124	0.087	0.201	0.142	0.265	0.196
			lb-in/A _{rms}	1.10	0.766	1.78	1.261	2.34	1.731
Back EMF Constant ②	±10%	K _e	V _{rms} /k _r rpm	8.09	5.64	13.09	9.28	17.2	12.7
Motor Constant ⑥	Nom	K _m	N-m/√W	0.211	0.210	0.335	0.332	0.422	0.428
			lb-in/√W	1.87	1.85	2.97	2.94	3.74	3.79
Resistance (line-line) ②	±10%	R _m	Ohm	0.230	0.114	0.240	0.122	0.262	0.139
Inductance Q-Axis (line-line)		L _{qll}	mH	0.54	0.26	0.57	0.29	0.61	0.33
Inductance D-Axis (line-line)		L _{dll}	mH	TBD	TBD	TBD	TBD	TBD	TBD
Inductance Saturation Current		L _{isat}	Arms	188	270	236	333	270	366
Maximum Demagnetization Current		Midpeak	Arms	TBD	TBD	TBD	TBD	TBD	TBD
Inertia (includes Resolver feedback) ③	±10%	J _m	kg-cm ²	0.426		0.813		1.200	
			lb-in-s ²	3.77E-04		7.20E-04		1.06E-03	
Optional Brake Inertia (additional)	±10%	J _m	kg-cm ²	0.120		0.120		0.120	
			lb-in-s ²	1.06E-04		1.06E-04		1.06E-04	
Weight without brake ④		W	kg	1.8		2.5		3.3	
			lb	4.0		5.6		7.2	
Static Friction ①⑤		T _f	Nm	0.013		0.023		0.031	
			lb-in	0.12		0.20		0.27	
Viscous Damping ①		K _{dv}	Nm/k _r rpm	0.0039		0.0078		0.0117	
			lb-in/k _r rpm	0.035		0.069		0.104	
Thermal Time Constant		TCT	minutes	17		21		25	
Coil Thermal Time Constant		MCT _{f0}		TBD		TBD		TBD	
Thermal Resistance ①		R _{thw-a}	K/W	0.980		0.868		0.795	
Pole Pairs		PP		4		4		4	
Heat Sink Size				10"x10"x1/4" Aluminum Plate		10"x10"x1/4" Aluminum Plate		10"x10"x1/4" Aluminum Plate	

Notes:

- ① Motor winding temperature rise, ΔT = 100° C, at 40° C ambient.
- ② Measured at 25° C.
- ③ Add parking brake if applicable for total inertia.
- ④ Brake motor adds 0.72 kg [1.6 lbs]
- ⑤ Shaft seal increases Static Friction by 0.017 Nm [0.15 lb-in]
- ⑥ This value is calculated from the Torque Constant and Resistance. Refer to those values and notes ① & ② for additional details.

*Complete AKM2G-3 low voltage servo motor series model nomenclature can be found on page 41.

AKM2G-3x Performance Curves

AKM2G-3x Torque-Speed Performance Curves – Up to 96 Vdc voltage

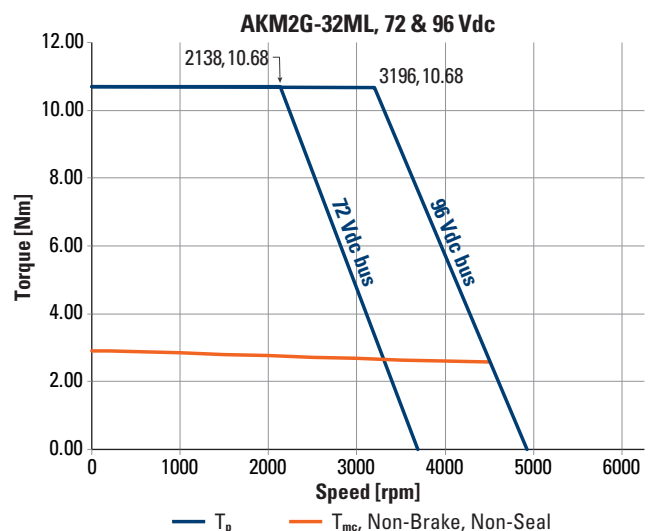
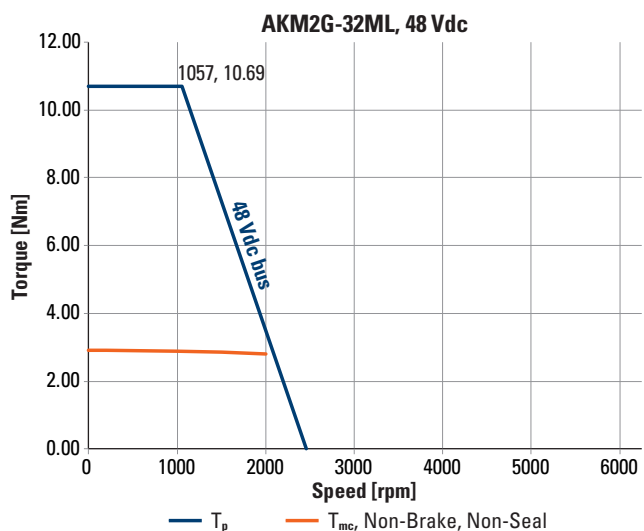
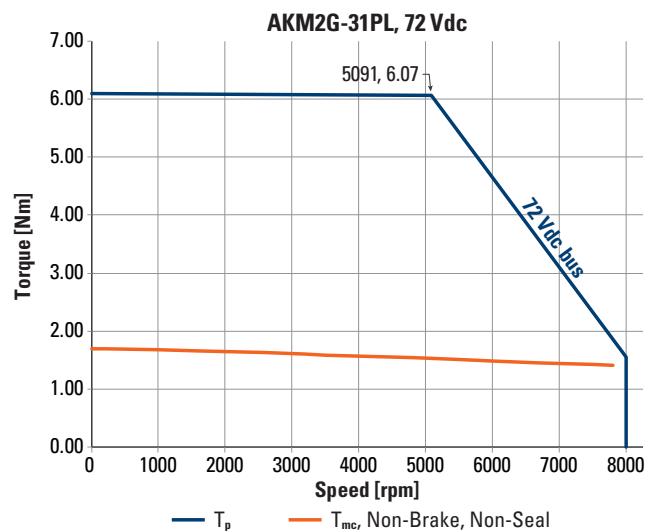
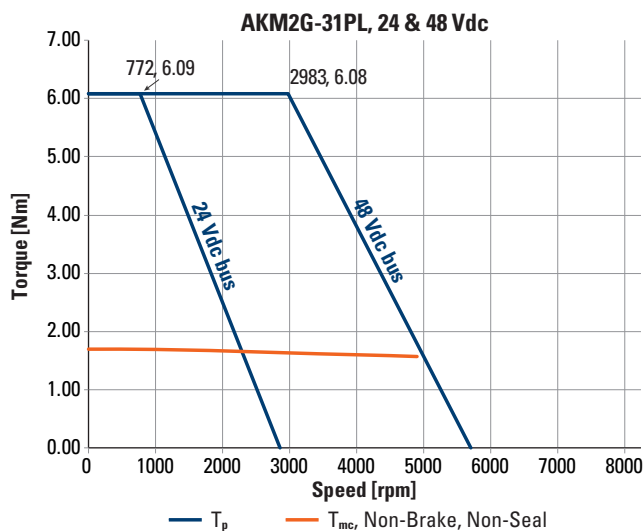
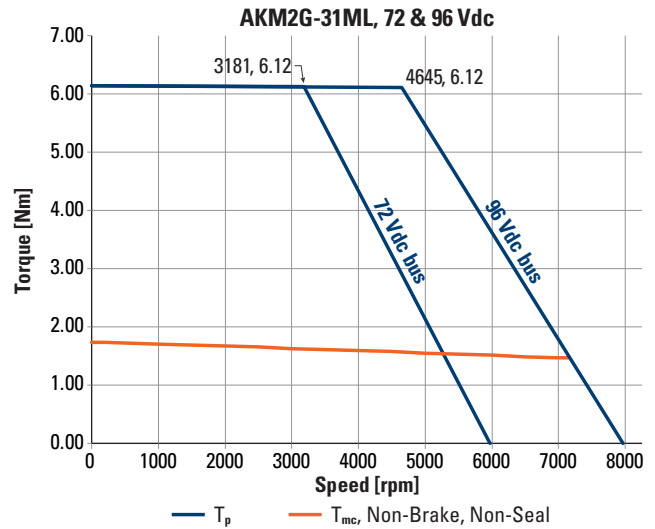
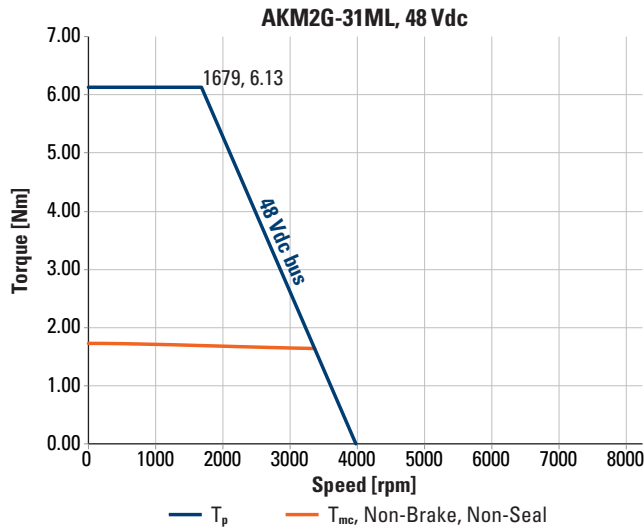

T_p = Peak torque
 T_{mc} = Maximum continuous torque
 Refer to page 40 for torque-speed curve properties.

AKM2G-3x Torque-Speed Performance Curves – Up to 96 Vdc voltage (continued)

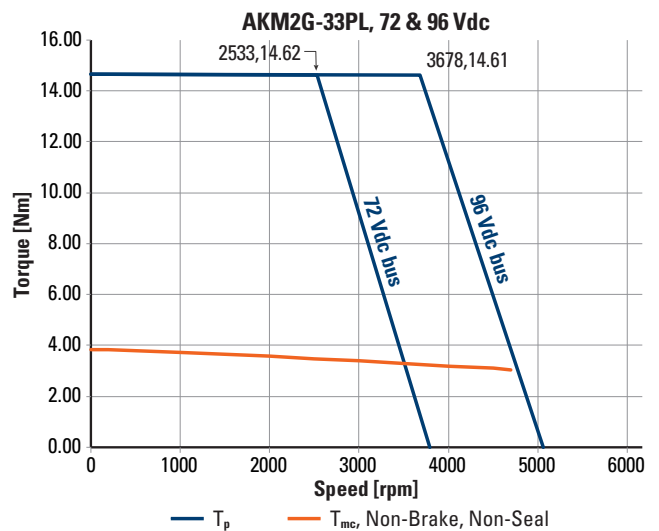
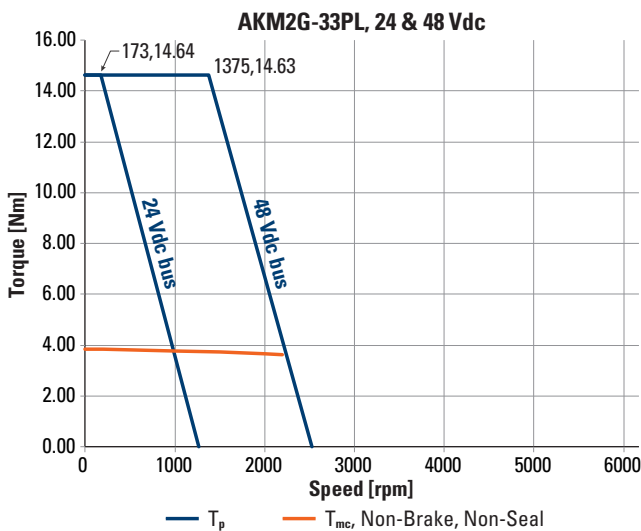
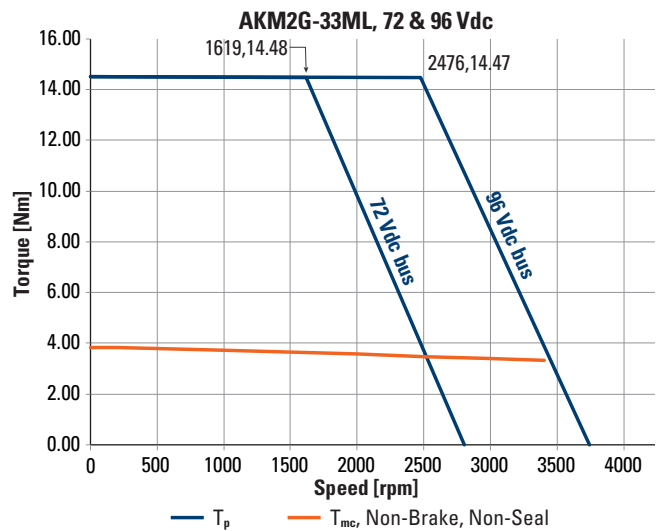
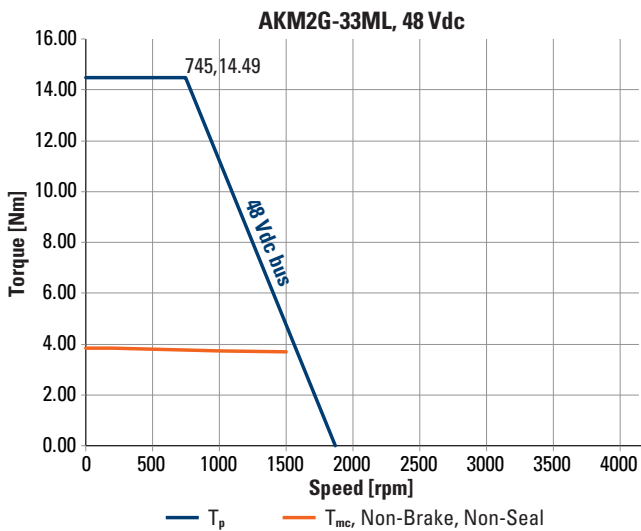
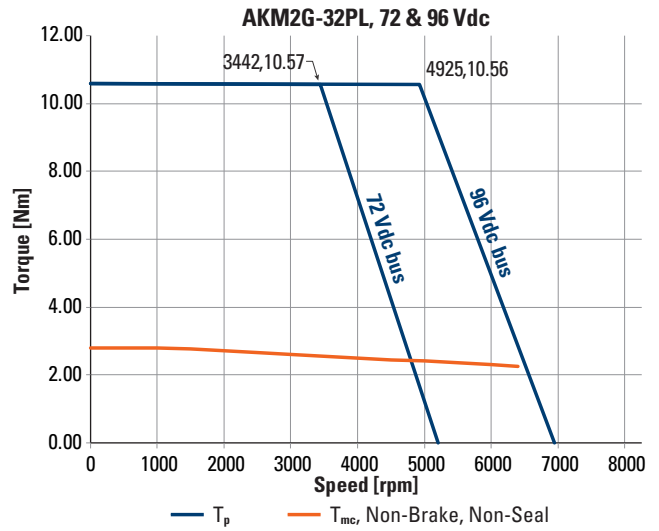
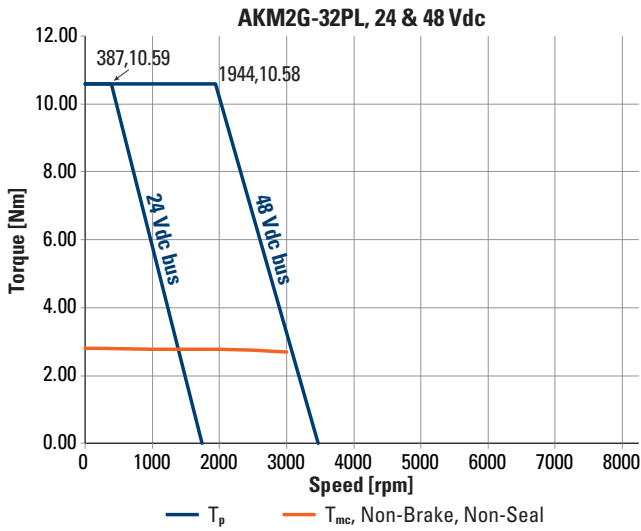

T_p = Peak torque
 T_{mc} = Maximum continuous torque
 Refer to page 40 for torque-speed curve properties.

AKM2G-3x Dimensional Drawings

AKM2G-3x Single Connector Frame

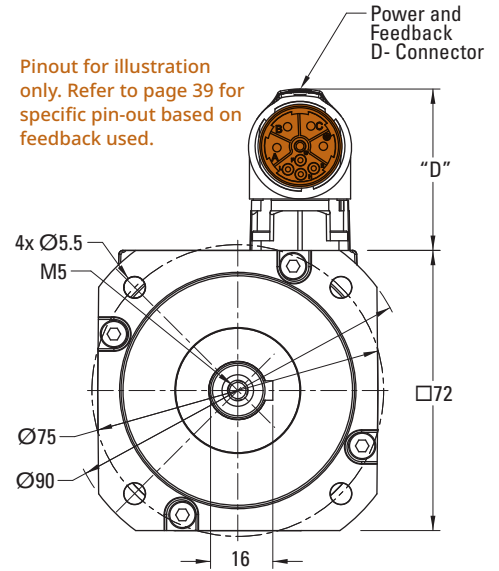
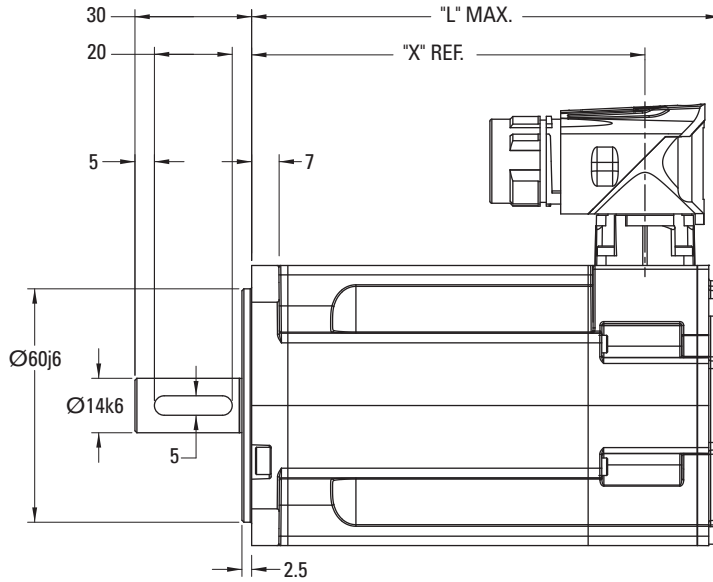

D- Connector Feedback	"D"
DSL & EnDat	42.8

AKM2G-3x "X" and "L" Dimensions

Model	No Brake		
	X	Resolver / Commutating Encoder L	DSL / EnDat 2.2 L
AKM2G-31L	101.1	121.4	129.4
AKM2G-32L	132.25	152.55	160.55
AKM2G-33L	163.4	183.7	191.7

Model	Brake		
	X	Resolver / Commutating Encoder L	DSL / EnDat 2.2 L
AKM2G-31L	142.3	162.6	170.6
AKM2G-32L	173.45	193.75	201.75
AKM2G-33L	204.6	224.9	232.9

AKM2G-3x Dual Connector Option

Pinouts for illustration only. Refer to page 38 for specific pin-out based on feedback used.

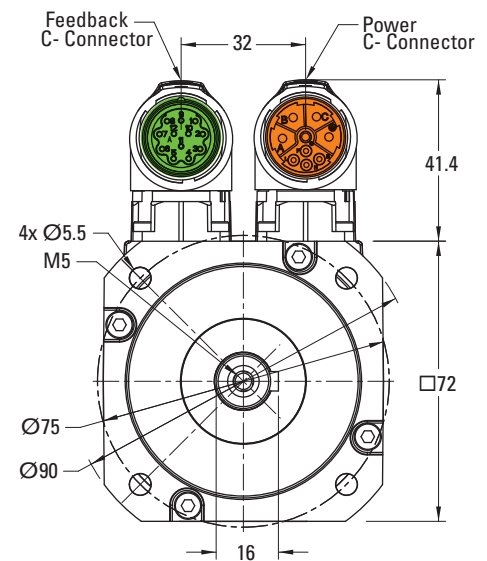

Notes

AKM2G - Motor Series
- 3 - Frame Size
2 - Rotor Length
ML - Winding
AN - Shaft Flange
C - Connection
N - Brake
2- - Feedback
10 - Customization Thermal Sensor

A large grid area for taking notes, with a 0.125 inch division size.

0.125 inch divisions

AKM2G-4x Performance Data

AKM2G-4x Low Voltage Servo Motor Performance Data – Up to 96 Vdc voltage

Parameters	Tol	Symbol	Units	AKM2G-41		AKM2G-42			AKM2G-43			AKM2G-44		
				ML	PL	ML	NL	PL	LL	ML	NL	LL	ML	NL
Max Rated Equivalent Line Voltage	Max	V _{bus}	Vdc	170	170	170	170	170	170	170	170	170	170	170
Max Continuous Torque for ΔT winding = 100°C ①②③	Nom	T _{CS}	Nm	2.91	2.91	5.17	5.17	5.16	7.07	7.06	7.06	8.59	8.60	8.59
			Ib-in	25.7	25.8	45.7	45.7	45.7	62.6	62.5	62.5	76.0	76.1	76.0
Continuous Current for ΔT winding = 100°C ①②③	Nom	I _{CS}	A _{RMS}	14.1	19.9	13.8	17.4	19.7	12.5	14.0	18.0	12.8	14.5	16.4
Max Continuous Torque for ΔT winding = 60°C ②③	Nom	T _{CS}	Nm	2.26	2.27	4.03	4.03	4.02	5.51	5.50	5.51	6.70	6.71	6.70
			Ib-in	20.0	20.1	35.6	35.7	35.6	48.7	48.7	48.7	59.3	59.4	59.3
Max Mechanical Speed ④	Nom	N _{max}	rpm	6000	6000	6000	6000	6000	6000	6000	6000	6000	6000	6000
Peak Torque ①②③	Nom	T _p	Nm	7.28	7.28	14.5	14.5	14.5	21.2	21.2	21.2	27.1	27.1	27.1
			Ib-in	64.4	64.4	128	128	128	188	188	188	240	240	240
Peak Current	Nom	I _p	A _{RMS}	56.2	79.7	55.1	69.8	78.8	50.2	56.0	71.8	51.3	58.2	65.7
Rated Torque (speed) ①②③		T _{rtd}	Nm	-	2.89	-	-	-	-	-	-	-	-	-
			Ib-in	-	25.6	-	-	-	-	-	-	-	-	-
Rated Speed		N _{rtd}	rpm	-	1000	-	-	-	-	-	-	-	-	-
Rated Power (speed) ①②③		P _{rtd}	kW	-	0.303	-	-	-	-	-	-	-	-	-
			Hp	-	0.406	-	-	-	-	-	-	-	-	-
Rated Torque (speed) ①②③		T _{rtd}	Nm	-	-	-	5.12	5.10	-	-	7.01	-	-	-
			Ib-in	-	-	-	45.3	45.1	-	-	62.0	-	-	-
Rated Speed		N _{rtd}	rpm	-	-	-	800	900	-	-	600	-	-	-
Rated Power (speed) ①②③		P _{rtd}	kW	-	-	-	0.429	0.480	-	-	0.440	-	-	-
			Hp	-	-	-	0.575	0.64	-	-	0.590	-	-	-
Rated Torque (speed) ①②③		T _{rtd}	Nm	2.85	2.80	5.10	5.08	5.04	-	7.00	6.96	-	8.54	8.50
			Ib-in	25.2	24.8	45.1	44.9	44.6	-	62.0	61.6	-	75.6	75.2
Rated Speed		N _{rtd}	rpm	1600	2300	900	1100	1300	-	600	800	-	500	600
Rated Power (speed) ①②③		P _{rtd}	kW	0.477	0.674	0.481	0.585	0.686	-	0.440	0.58	-	0.447	0.534
			Hp	0.639	0.904	0.645	0.78	0.92	-	0.59	0.78	-	0.600	0.716
Rated Torque (speed) ①②③		T _{rtd}	Nm	2.78	2.68	5.02	4.96	4.89	6.94	6.91	6.83	8.46	8.41	8.36
			Ib-in	24.6	23.7	44.5	43.9	43.3	61.4	61.1	60.4	74.9	74.4	74.0
Rated Speed		N _{rtd}	rpm	2500	3600	1400	1800	2100	900	1000	1300	700	900	1000
Rated Power (speed) ①②③		P _{rtd}	kW	0.727	1.01	0.736	0.93	1.08	0.654	0.724	0.93	0.620	0.793	0.875
			Hp	0.97	1.35	0.988	1.25	1.44	0.88	0.97	1.25	0.832	1.06	1.17
Rated Torque (speed) ①②③		T _{rtd}	Nm	2.69	2.51	4.93	4.81	4.73	6.86	6.80	6.65	8.35	8.29	8.20
			Ib-in	23.8	22.2	43.6	42.6	41.8	60.7	60.2	58.8	73.9	73.4	72.5
Rated Speed		N _{rtd}	rpm	3400	5000	1900	2500	2800	1200	1400	1900	1000	1200	1400
Rated Power (speed) ①②③		P _{rtd}	kW	0.96	1.31	0.98	1.26	1.39	0.86	1.00	1.32	0.874	1.04	1.20
			Hp	1.28	1.76	1.32	1.69	1.86	1.16	1.34	1.77	1.17	1.40	1.61
Rated Torque (speed) ①②③		T _{rtd}	Nm	-	-	-	-	-	-	-	-	8.28	8.21	8.11
			Ib-in	-	-	-	-	-	-	-	-	-	73.2	72.6
Rated Speed		N _{rtd}	rpm	-	-	-	-	-	-	-	-	1200	1400	1600
Rated Power (speed) ①②③		P _{rtd}	kW	-	-	-	-	-	-	-	-	1.040	1.20	1.36
			Hp	-	-	-	-	-	-	-	-	-	1.39	1.61

Notes:

- ① Motor winding temperature rise, ΔT = 100° C, at 40° C ambient.
- ② All data referenced to sinusoidal commutation.
- ③ Motor with resolver feedback and standard heat sink.
- ④ May be limited at some values of V_{bus}.

AKM2G-4x Low Voltage Servo Motor Performance Data – Up to 96 Vdc voltage (continued)

Parameters	Tol	Symbol	Units	AKM2G-41		AKM2G-42			AKM2G-43			AKM2G-44		
				ML	PL	ML	NL	PL	LL	ML	NL	LL	ML	NL
Torque Constant ①	±10%	K_t	Nm/A _{rms}	0.209	0.147	0.378	0.298	0.263	0.567	0.507	0.395	0.674	0.595	0.525
			lb-in/A _{rms}	1.85	1.30	3.34	2.64	2.33	5.02	4.49	3.50	5.97	5.26	4.65
Back EMF Constant ②	±10%	K_e	V _{rms} /k _r rpm	13.8	9.75	25.2	19.9	17.6	38.0	34.0	26.5	45.5	40.1	35.5
Motor Constant ⑥	Nom	K_m	N-m/√W	0.333	0.334	0.536	0.536	0.536	0.687	0.686	0.687	0.809	0.810	0.809
			lb-in/√W	2.95	2.96	4.74	4.75	4.74	6.08	6.07	6.08	7.16	7.17	7.16
Resistance (line-line) ②	±10%	R_m	Ohm	0.262	0.130	0.331	0.206	0.161	0.454	0.364	0.221	0.463	0.359	0.281
Inductance Q-Axis (line-line)		L_{qll}	mH	1.6	0.80	2.3	1.5	1.1	3.4	2.7	1.6	3.6	2.8	2.2
Inductance D-Axis (line-line)		L_{dll}	mH	TBD	TBD	TBD	TBD	TBD	TBD	TBD	TBD	TBD	TBD	TBD
Inductance Saturation Current		I_{sat}	Arms	71	101	80	101	114	80	89	114	89	101	114
Maximum Demagnetization Current		Midpeak	Arms	TBD	TBD	TBD	TBD	TBD	TBD	TBD	TBD	TBD	TBD	TBD
Inertia (includes Resolver feedback) ③	±10%	J_m	kg-cm ²	0.774		1.36			1.95			2.53		
			lb-in-s ²	6.85E-04		1.20E-03			1.72E-03			2.24E-03		
Optional Brake Inertia (additional)	±10%	J_m	kg-cm ²	0.360		0.36			0.36			0.360		
			lb-in-s ²	3.19E-04		3.19E-04			3.19E-04			3.19E-04		
Weight without brake ④		W	kg	2.90		3.86			4.81			5.76		
			lb	6.39		8.5			10.6			12.7		
Static Friction ①⑤		T_f	Nm	0.0230		0.030			0.0380			0.0450		
			lb-in	0.2036		0.27			0.336			0.398		
Viscous Damping ①		K_{dv}	Nm/k _r rpm	0.00450		0.009			0.0125			0.0163		
			lb-in/k _r rpm	0.0398		0.08			0.111			0.144		
Thermal Time Constant		TCT	minutes	17		22			27			32		
Coil Thermal Time Constant		MCT_{f0}		TBD		TBD			TBD			TBD		
Thermal Resistance ①		R_{thw-a}	K/W	0.880		0.725			0.637			0.598		
Pole Pairs		PP		5		5			5			5		
Heat Sink Size				10"x10"x1/4" Aluminum Plate		10"x10"x1/4" Aluminum Plate			10"x10"x1/4" Aluminum Plate			10"x10"x1/4" Aluminum Plate		

Notes:

① Motor winding temperature rise, ΔT = 100° C, at 40° C ambient.

② Measured at 25° C.

③ Add parking brake if applicable for total inertia.

④ Brake motor adds 1.36 kg [3.0 lbs]

⑤ Shaft seal increases Static Friction by 0.023 Nm [0.20 lb-in]

⑥ This value is calculated from the Torque Constant and Resistance. Refer to those values and notes ① & ② for additional details.

*Complete AKM2G-4 low voltage servo motor series model nomenclature can be found on page 41.

AKM2G-4x Performance Curves

AKM2G-4x Low Voltage Servo Motor Performance Data – Up to 96 Vdc voltage

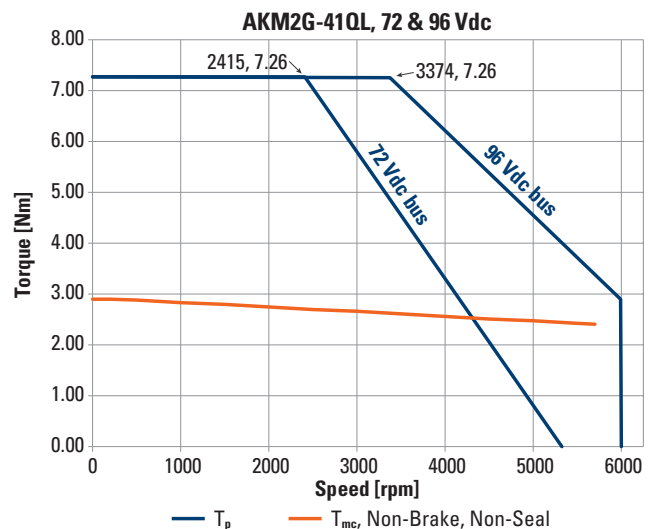
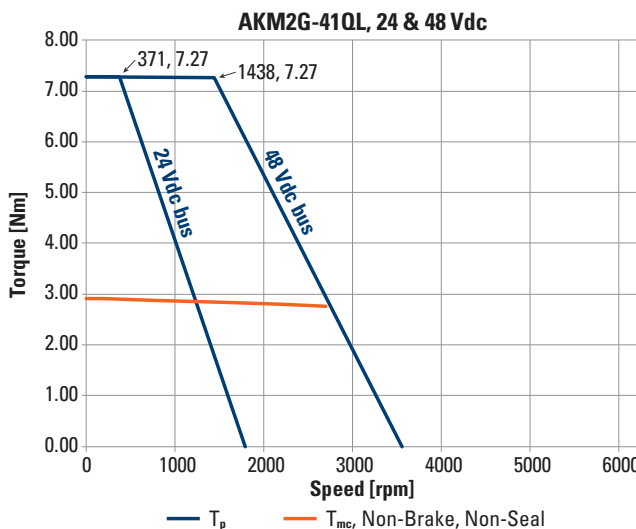
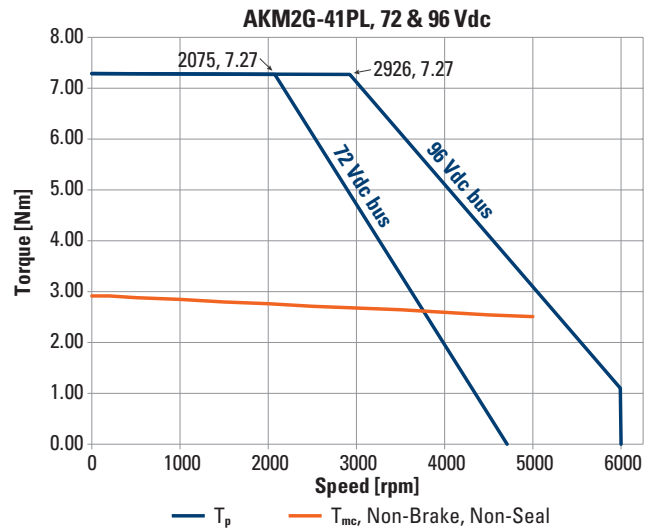
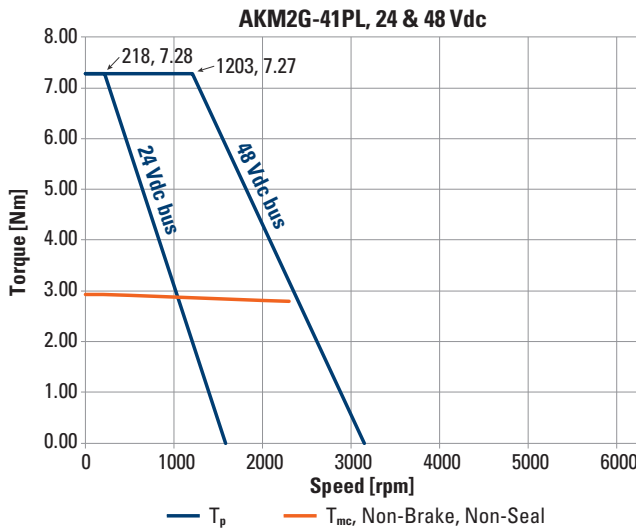
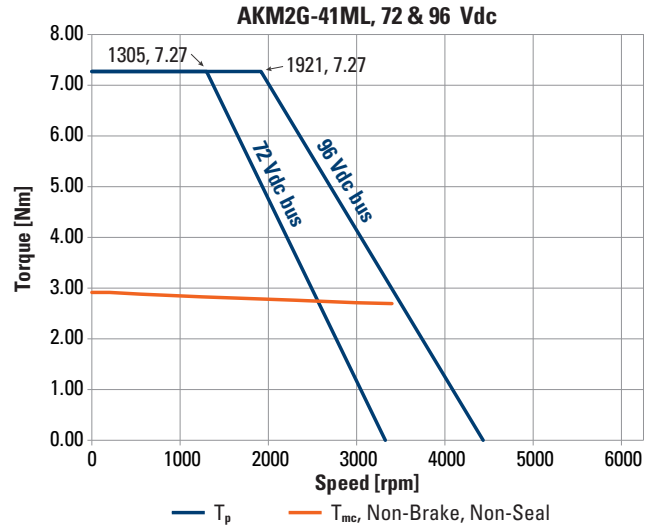
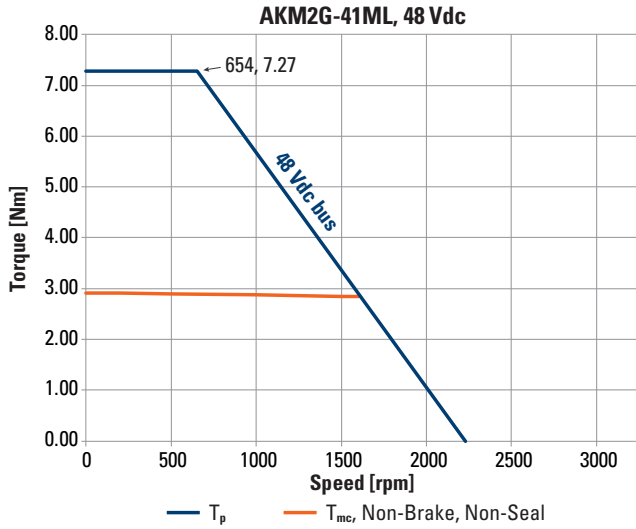

T_p = Peak torque
 T_{mc} = Maximum continuous torque
 Refer to page 40 for torque-speed curve properties.

AKM2G-4x Low Voltage Servo Motor Performance Data – Up to 96 Vdc voltage (continued)

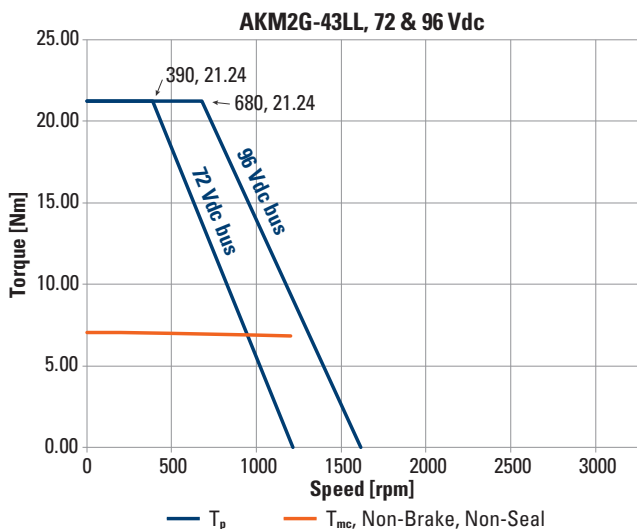
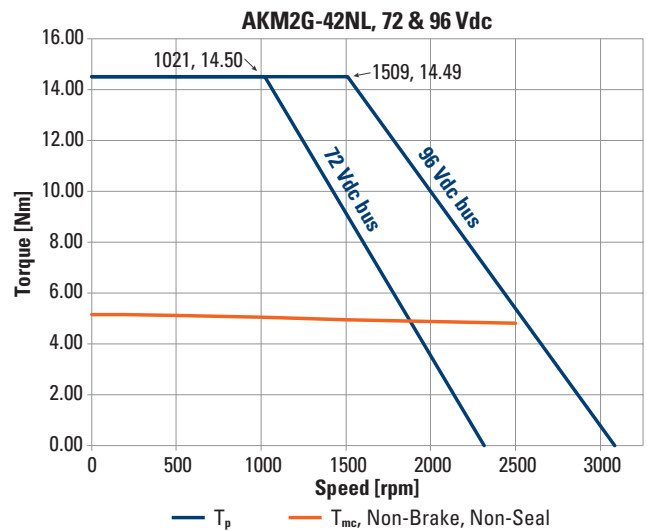
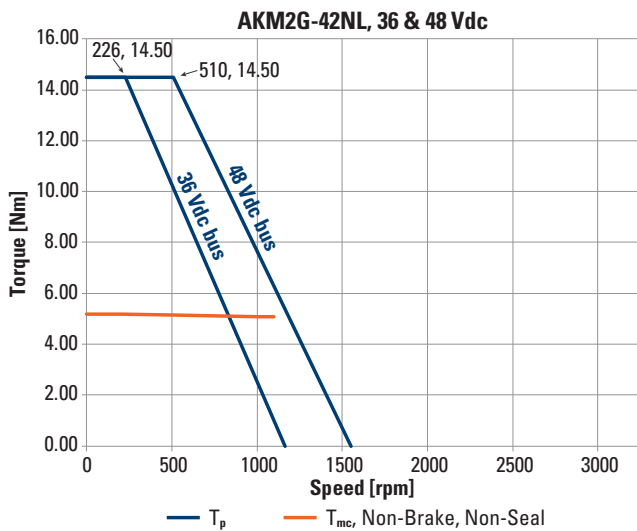
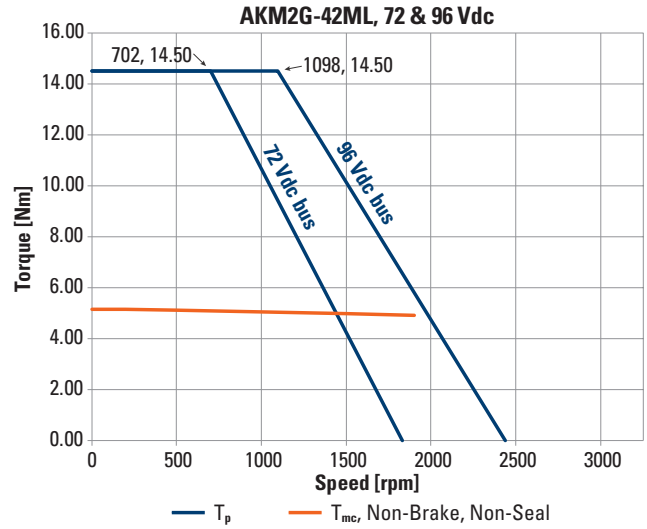
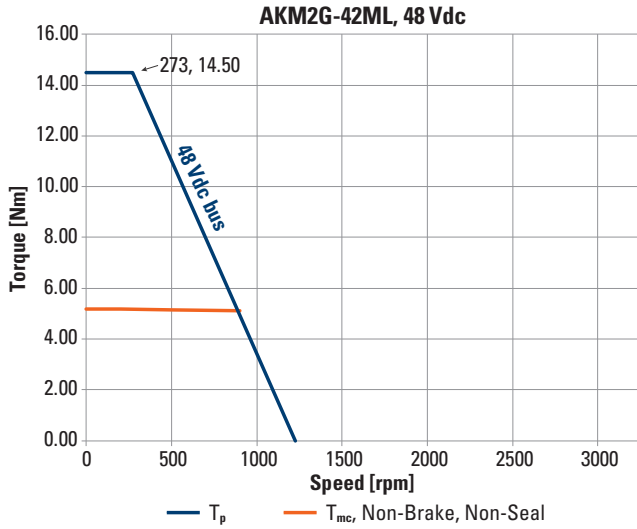

T_p = Peak torque
 T_{mc} = Maximum continuous torque
 Refer to page 40 for torque-speed curve properties.

AKM2G-4x Performance Curves

AKM2G-4x Low Voltage Servo Motor Performance Data – Up to 96 Vdc voltage (continued)

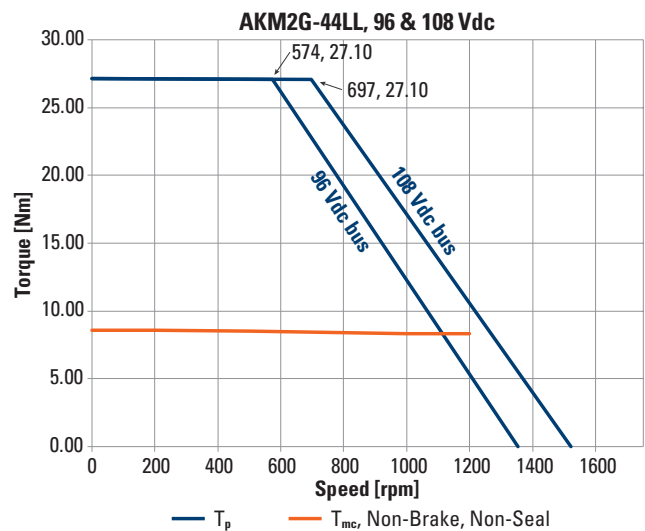
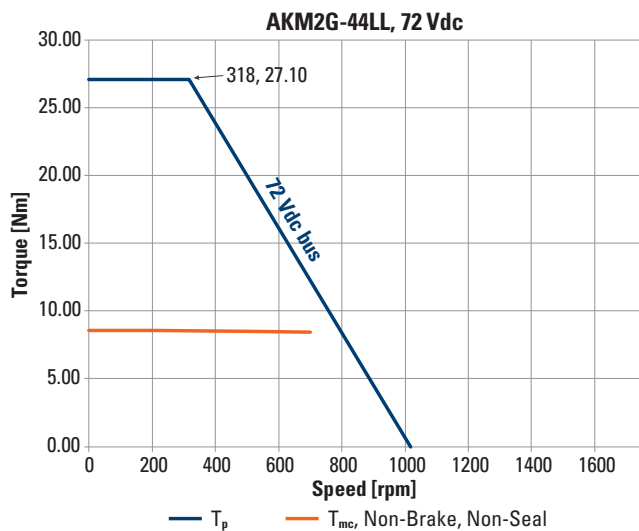
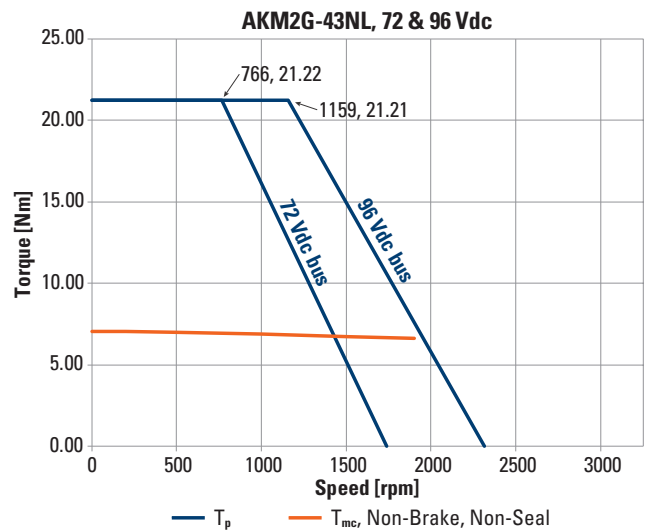
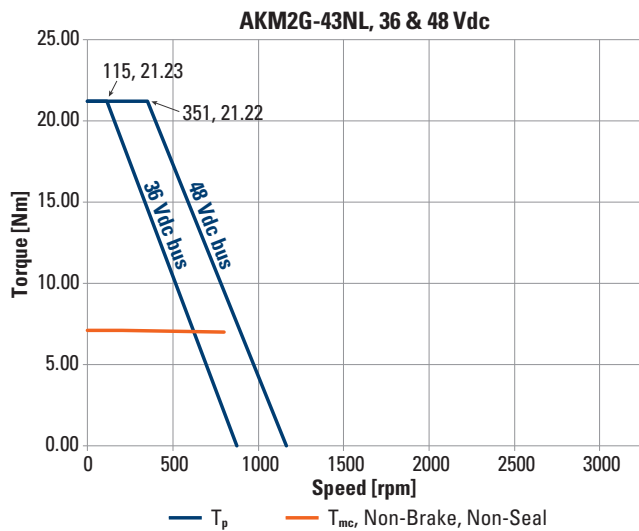
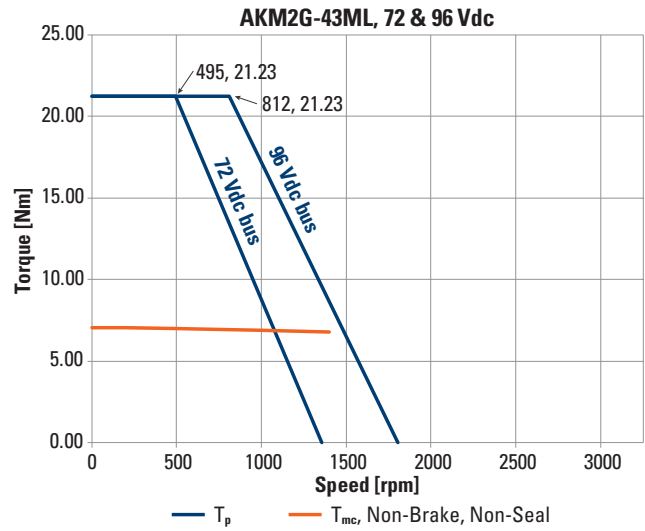
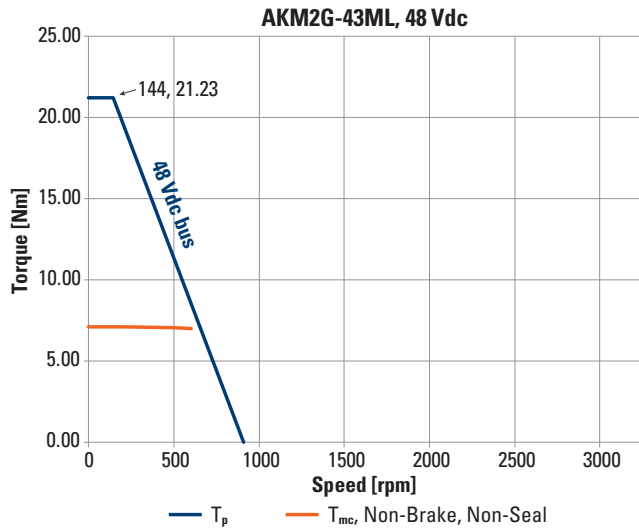

T_p = Peak torque
 T_{mc} = Maximum continuous torque
 Refer to page 40 for torque-speed curve properties.

AKM2G-4x Low Voltage Servo Motor Performance Data – Up to 96 Vdc voltage (continued)

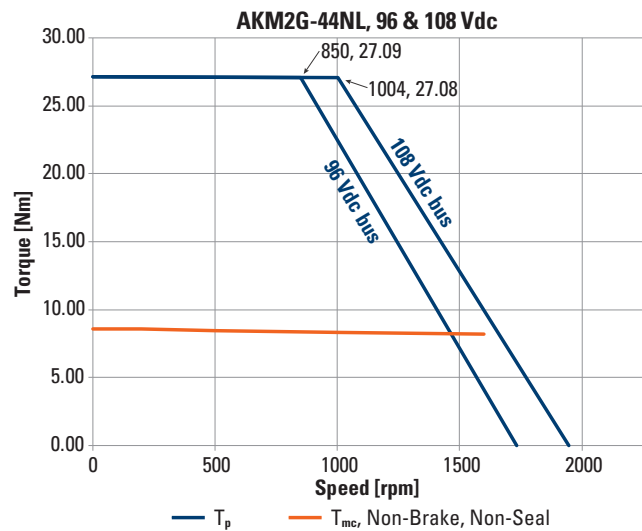
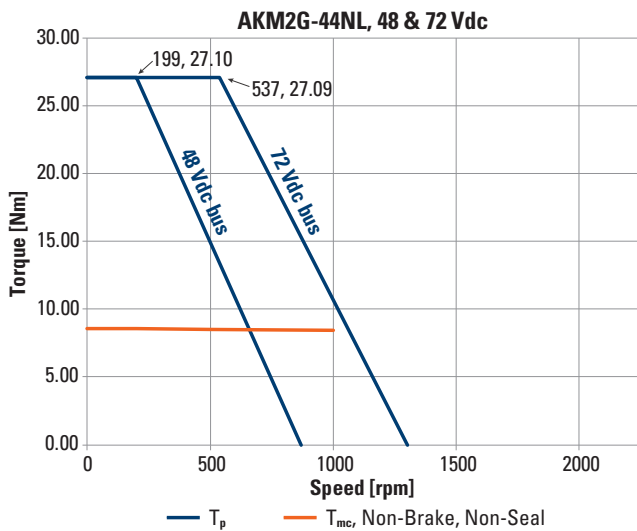
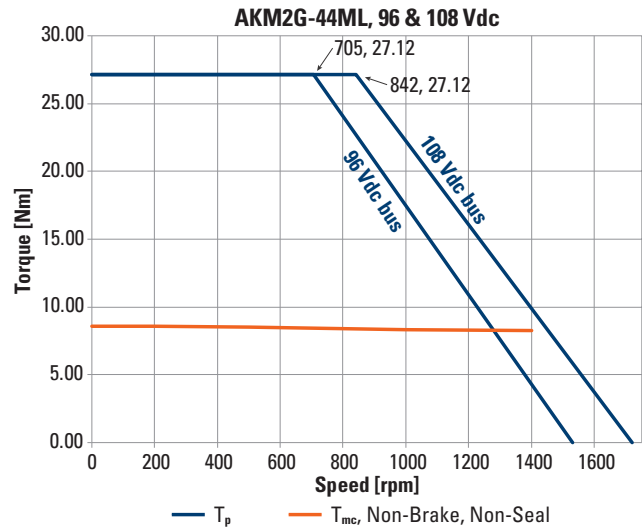
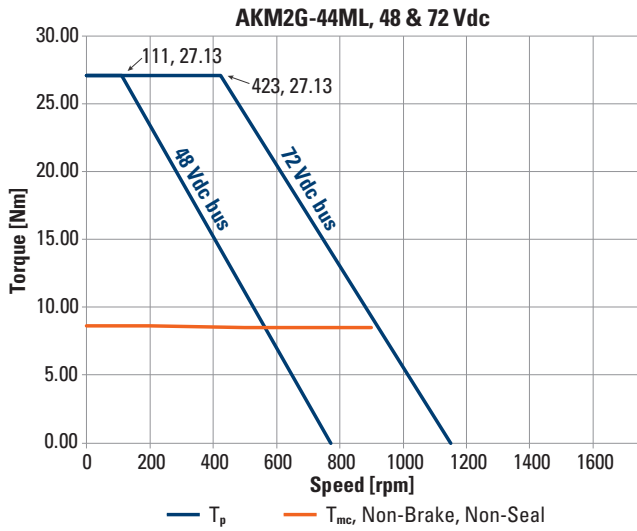

T_p = Peak torque
 T_{mc} = Maximum continuous torque
 Refer to page 40 for torque-speed curve properties.

AKM2G-4x Dimensional Drawings

AKM2G-4x Single Connector Frame

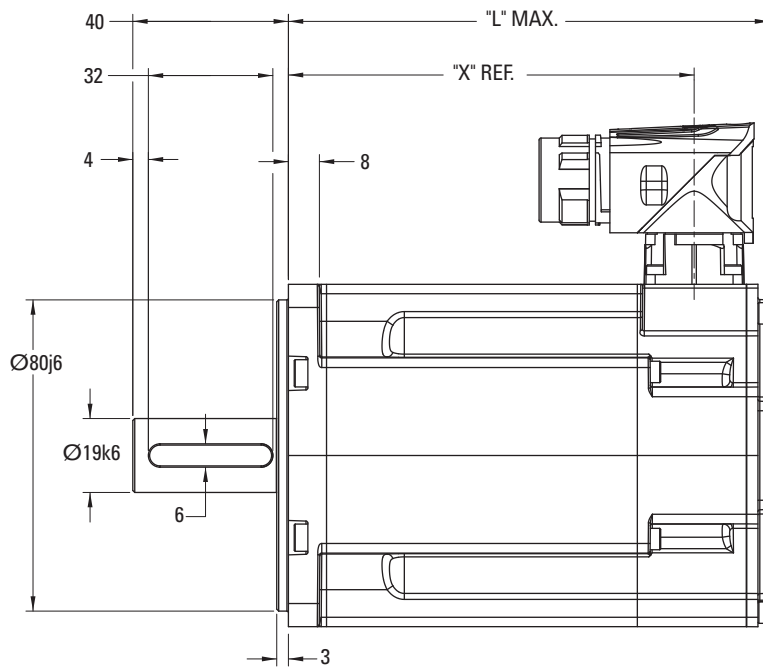

Pinout for illustration only. Refer to page 39 for specific pin-out based on feedback used.

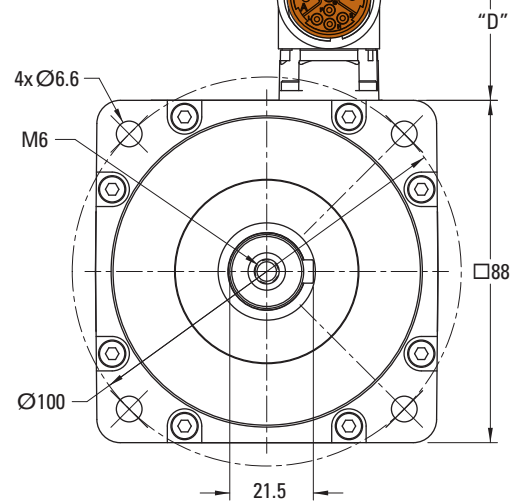

D- Connector Feedback	"D"
DSL & EnDat	42.8

AKM2G-4x "X" and "L" Dimensions

Model	No Brake		
	X	Resolver / Commutating Encoder	DSL / EnDat 2.2
AKM2G-41L	104.3	124.6	132.6
AKM2G-42L	130.55	150.85	158.85
AKM2G-43L	156.8	177.1	185.1
AKM2G-44L	183.05	203.35	211.35

Model	Brake		
	X	Resolver / Commutating Encoder	DSL / EnDat 2.2
AKM2G-41L	152.1	172.4	180.4
AKM2G-42L	178.35	198.65	206.65
AKM2G-43L	204.6	224.9	232.9
AKM2G-44L	230.85	251.15	259.15

AKM2G-4x Dual Connector Option

Pinouts for illustration only. Refer to page 38 for specific pin-out based on feedback used.

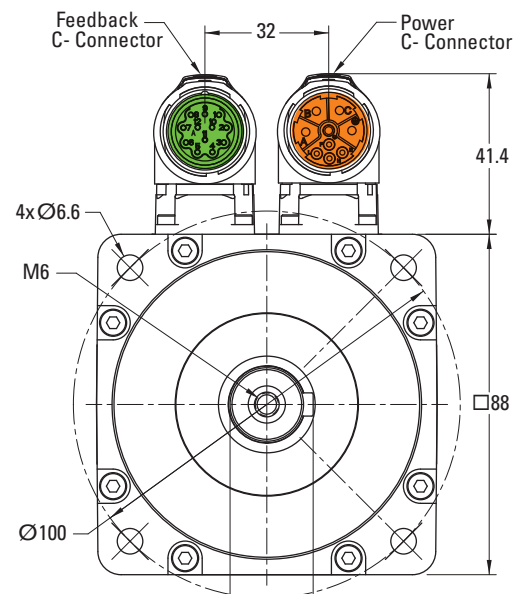

Notes

AKM2G - **4** **2** **ML** **AN** **C** **N** **2-** **10**
Motor Series Frame Size Rotor Length Winding Shaft Flange Connection Brake Feedback Customization Thermal Sensor

0.125 inch divisions

L10 Bearing Fatigue & Shaft Loading

Bearing Life

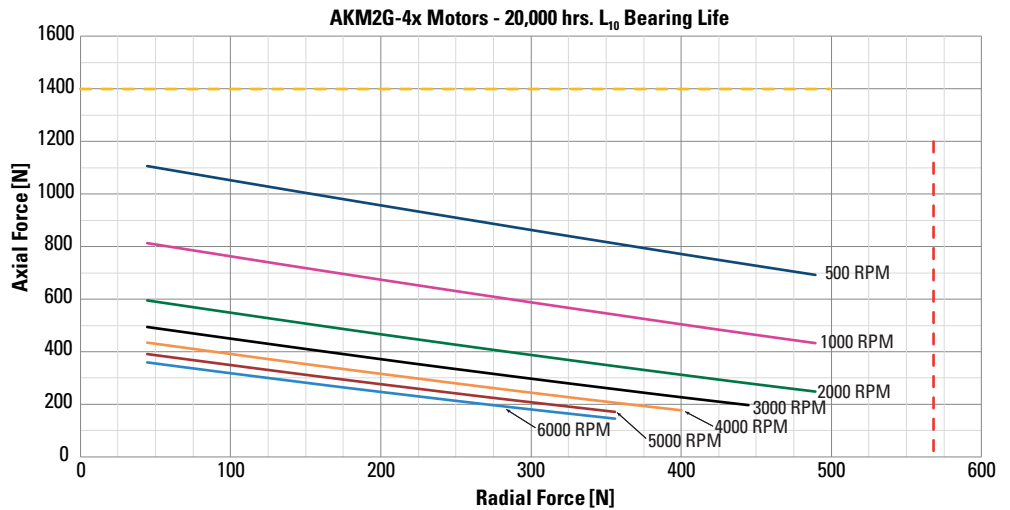
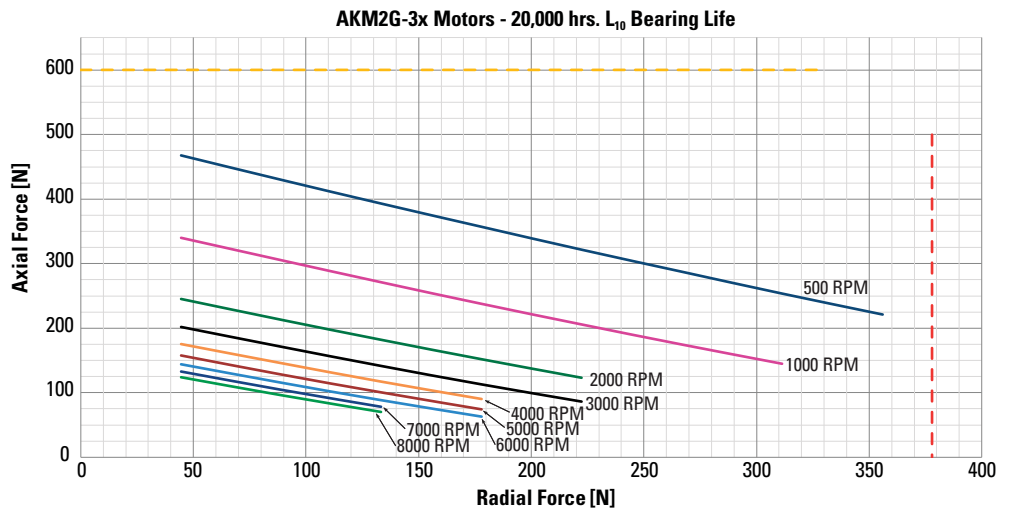
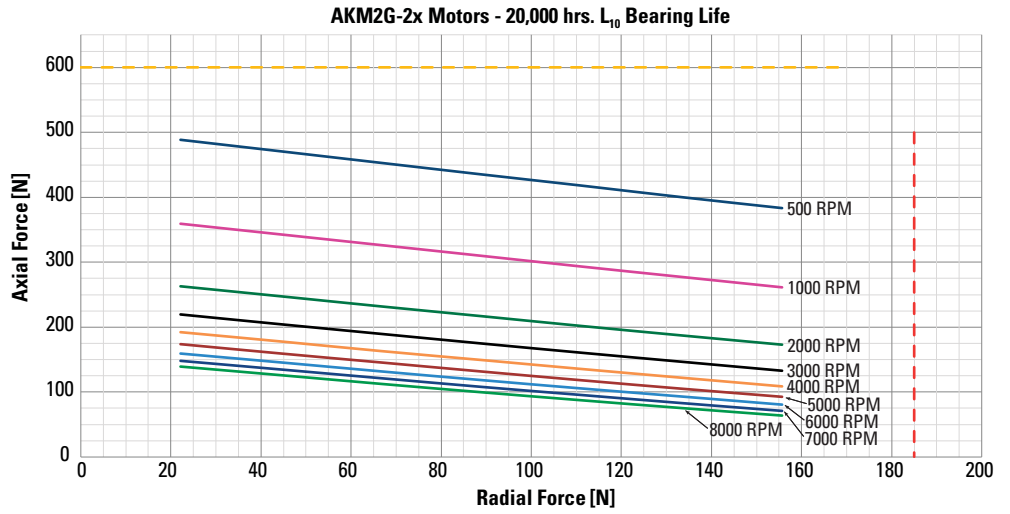

Shaft Loading

Motor	Max. Radial Force (N)	Max. Axial Force (N)
AKM2G-2	195	600
AKM2G-3	340	600
AKM2G-4	560	1400

The maximum radial load ratings reflect the following assumptions:

Motors are operated with peak torque of the longest member of the frame size.

Fully reversed load applied to the end of the smallest diameter standard mounting shaft extension.

Infinite life with 99% reliability.

Safety factor = 2.

Mineral-filled PTFE Teflon® Shaft Seals

There is a normal break-in period for our Mineral-filled PTFE Teflon® shaft seals. Best conditions during the break-in period would be at the operational temperature and speed that would be typical for the application.

During the break-in period, some “shedding” of mineral-filled PTFE Teflon material is normal. The debris is not a sign of seal deterioration or failure. The material “shed” should be reduced with usage.

Typically, a few hours at operational speed is enough to break-in the shaft seal.

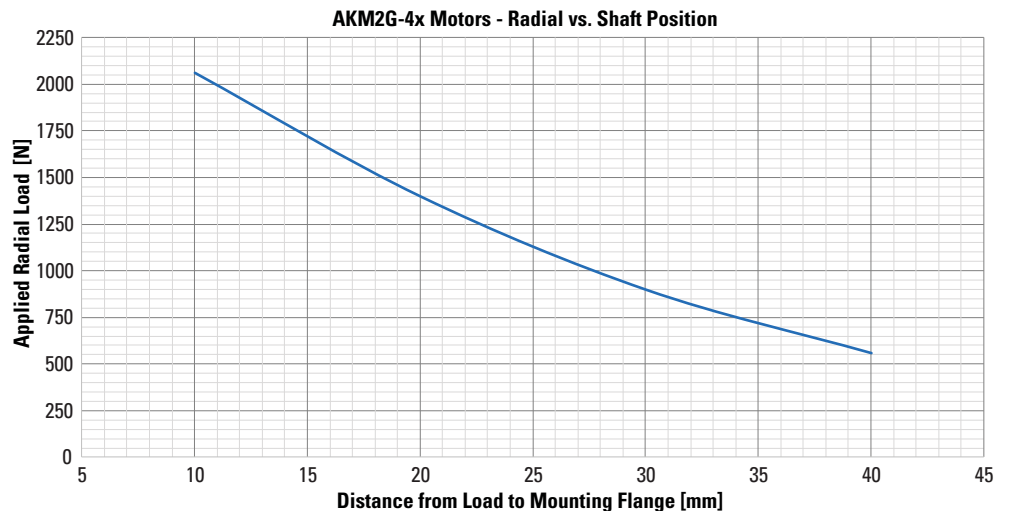
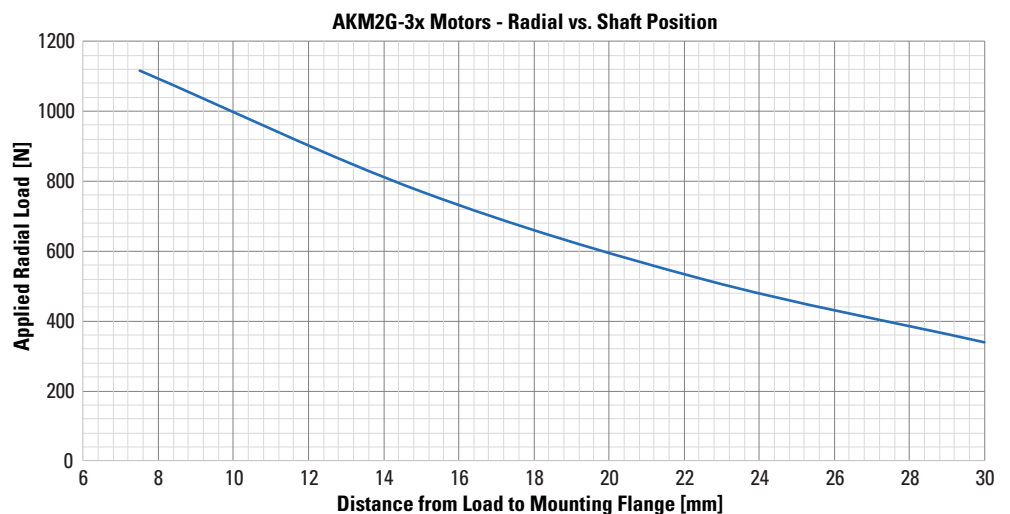
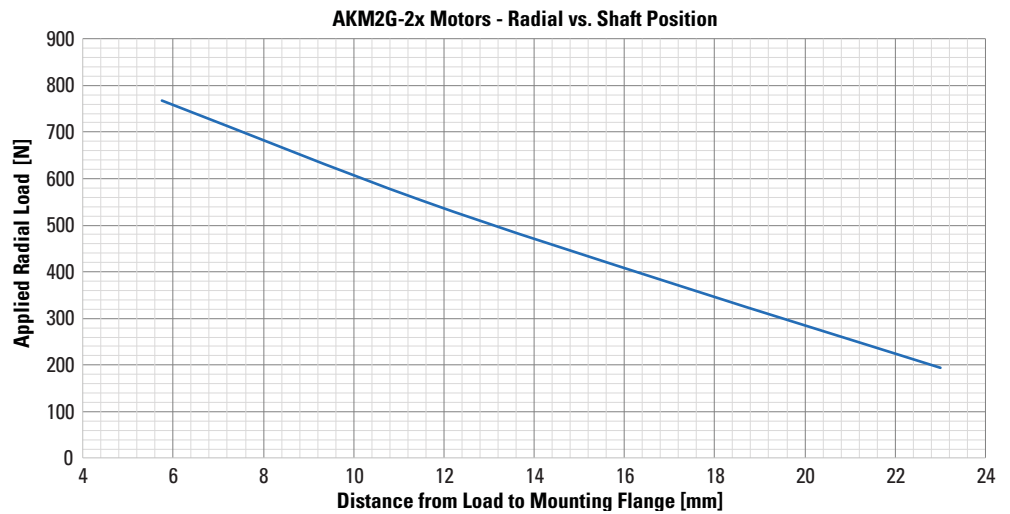

▶ Thermal Sensor Protective Devices

The standard version of each motor is fitted with an electrically isolated PT-1000. The thermal sensors do not provide any protection against short, heavy overloading.

The motor can be delivered with a PT-1000 + PTC, PTC, or KTY 84-130 equivalent sensors optionally (see Thermal Sensor options 2, 3, 0).

With digital feedback systems Hiperface DSL (GU) and EnDat 2.2 (LD) the temperature sensor status is transmitted digitally and evaluated in the drive.

Provided that our configured feedback cables are used, the sensor is integrated into the monitoring system of the digital servo amplifiers.

Thermal Device Options: Resistance vs. Temperature Graphs

Kollmorgen AKD drives can directly interpret information from the motor thermal sensors to properly reflect the motor winding temperature. For other drives please refer to the graph Delta Between Motor Winding and Thermal Device on the following page.

Standard 1

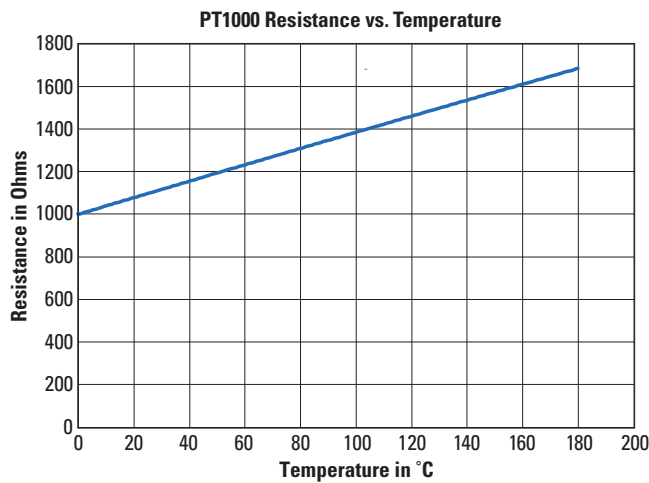

Option 2

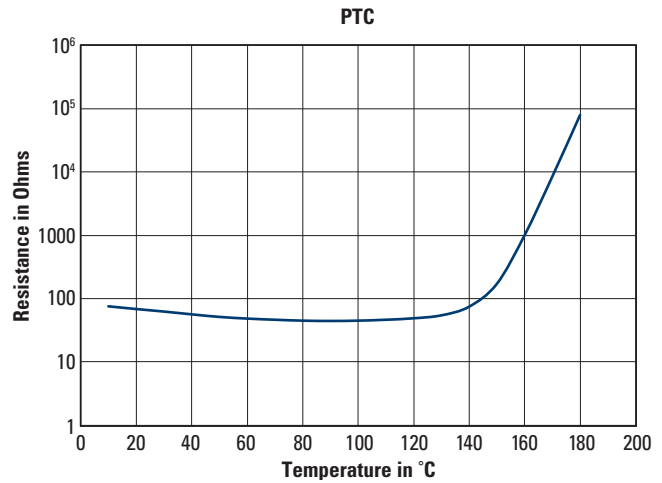

Option 3

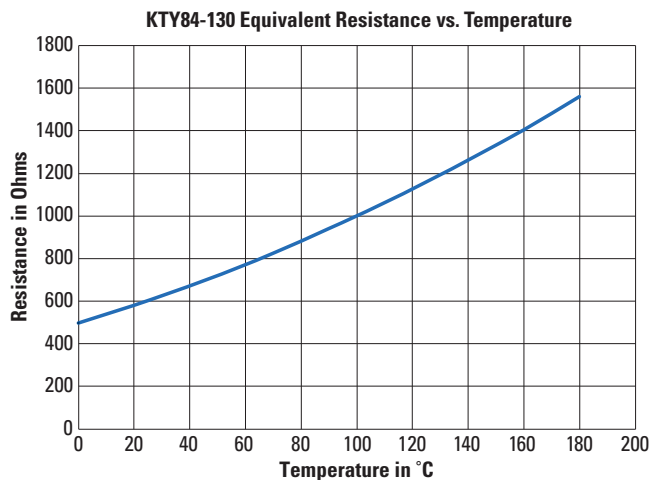

Option 0

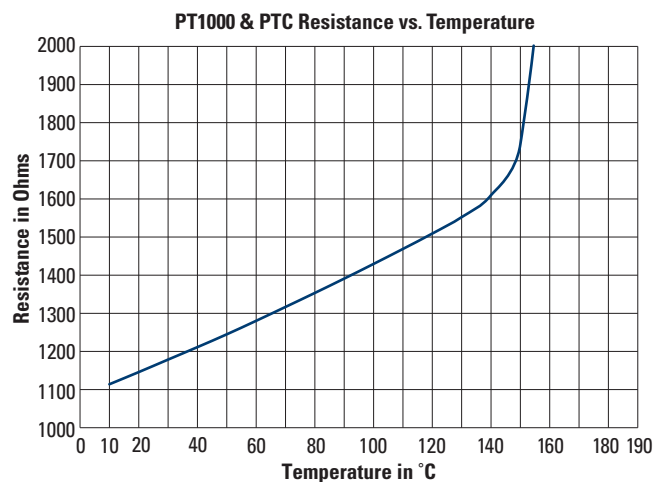

Delta Between Motor Winding and Thermal Device

When using a drive other than the Kollmorgen AKD you will need to account for the difference (Delta) in temperature between the value reported by the thermal sensor and the actual motor winding temperature. This is necessary to insure proper operation and protection of the motor.

The provided graph shows the delta between the reported device temperature on the x axis and the motor winding temperature on the y axis and should be used to adjust the response of the system for the difference between the thermal sensors reported temperature and the actual motor winding temperature.

Examples:

At 60°C on thermal device temperature the winding temperature will be 1.8°C higher (61.8°C).

At 130°C on thermal device temperature the winding temperature will be 8.1°C higher (138.1°C).

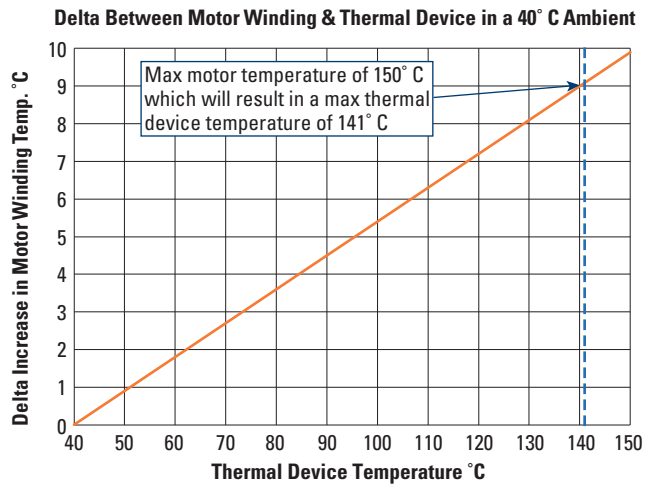

▶ Brake Option

Failsafe, Holding Brake

The holding brake is designed to provide static holding torque to the motor shaft with the brake coil de-energized. The brake must first be released (coil energized) prior to commanding motor rotation as determined by its drop-out time. The brake is intended for holding or “parking” of a stationary motor. It is not intended for dynamic braking. There should be absolutely no motion of the rotor when power is removed from the brake coil.

AKM2G Motor Brake Specifications

Motor Family	Minimum Static Torque @120°C		Weight Adder		Power Consumption Nominal Watts ±7%	Current ¹ @24 V, 20°C ADC	Inertia Adder		Closing Time (engage) msec	Opening Time (release) msec	Backlash ²	
	Nm	lb-in	Kg	lb			kg-cm ²	lb-in-sec ²			Maximum deg.	Typical deg.
AKM2G-2	2	17.7	0.45	1.0	11.4	0.47	0.04	3.5E-05	10	40	1	0.32
AKM2G-3	3.3	29.205	0.72	1.6	12.6	0.53	0.12	1.1E-04	17	55	1	0.6
AKM2G-4	7	62.0	1.36	3.0	14.7	0.61	0.36	3.2E-04	20	85	1	0.55

Contamination of the motor internal compartment by oil or other foreign materials will result in failure of the brake. Check the suitability of motor sealing for the working environment.

Note 1: Operating Voltage: 24 Vdc ± 10%.

Note 2: Maximum backlash is calculated using worst-case tolerancing, and typical backlash is calculated using statistical tolerancing.

Feedback Options

Phasing Diagram - All Motors

Motor Winding Configuration

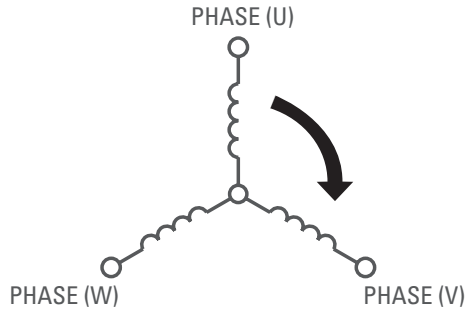

General note:

When motor is rotated CW (viewed from drive shaft end), these waveforms result:

Voltage U , leads V , leads W.

Voltage U-W leads Voltage V-W by 60° electrical.

AKM2G LV Servo Motor Feedback Summary

Available Models ⁵	Code	Description	Connector	Type	Size	Motor ID Support ³	Accuracy ^{1,2} (arc-sec)	RMS Noise ¹ (arc-sec)	Resolution	Absolute revs.
3, 4	2-	Commutating Encoder	C/G	Optical	15	No	±218.2"	N/A	12 bits	None
2, 3, 4	GU	HIPERFACE DSL®	D	Capacitive	EEM37	Yes	±240"	±20"	17 bits	4096
2, 3, 4	LD	EnDat® 2.2	D	Inductive	EQI 1131	Yes	±120"	See Note 4	19 bits	4096
3, 4	R-	Resolver	C/G	Inductive	15	No	±540"	N/A	24 bits for AKD	1

Note 1: AKD drives have a resolver measurement accuracy of ±45", for a drive w/ motor accuracy of ±585" and RMS Noise of ±9.9" Accuracy & RMS Noise data when used with other drives may be different.

Note 2: Accuracy refers to overall system accuracy once installed in the motor. Noise refers to the RMS position noise when at stand-still.

Note 3: Motor ID support means electronic motor nameplate data is included, allowing for plug-and-play commissioning.

Note 4: At the time of printing, this information was not available. Please contact Kollmorgen Customer Support for the latest update.

Note 5: AKM2G-LV Size 2 models are only available in single-connector configurations.

With AKD drives, all received positions are interpolated to a 32-bit resolution per revolution. When using a drive other than AKD consult the drive manufacturer for this information.

Connector Options Summary for Low Voltage Servo Motors

Available Models	Model Designation	Connection	Position of connection
3, 4	C	2 SpeedTec® M23	Angular, rotatable, motor mounted
2, 3, 4	D*	1 htec® M23	Angular, rotatable, motor mounted
3, 4	G	2 SpeedTec® M23	Straight, motor mounted

* Hybrid connectors valid for DSL and EnDat Feedback only.

Servo Motor Feedback Combinations

Commutating Encoder Feedback Option (2-)

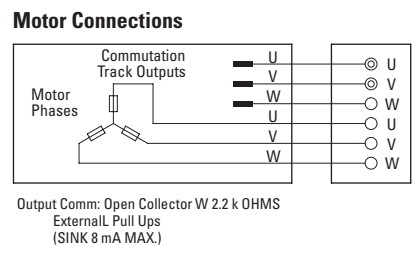
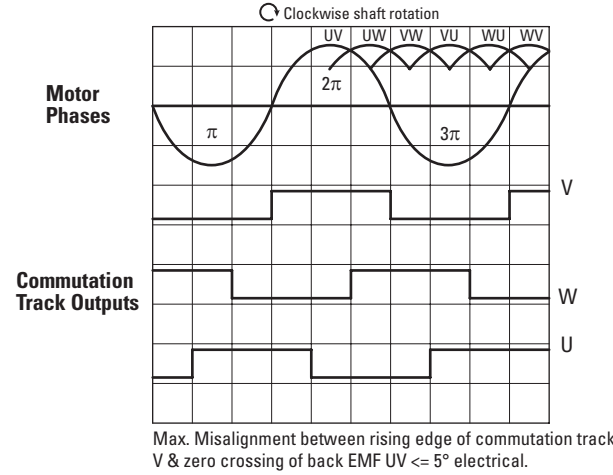
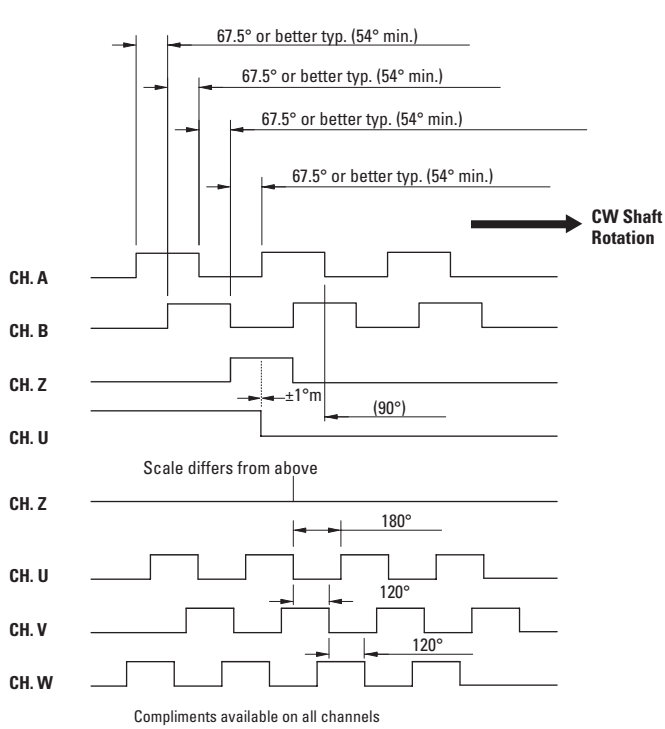

Parameter	Units	2-
Input Voltage	Vdc ±10%	5
Output Data		26LS31 Diff. Line Driver. Sink/Source 40mA Max
Line Count		2,048
Frequency Response	KHz	200
Max. Speed	RPM	8,000
Min. Edge Separation of Incremental Channel	°e MIN.	45
Index to U Comm Channel		±/-1°m Index Center To U Falling Edge
Index Pulse Width		Gated With B Low
Incremental Channel Accuracy		±1 Arc Min. Max. Edge to Edge
Max. Acceleration	Rad/s ²	100,000
Operating Temperature	°C	0 - 120
Storage Temperature	°C	-40 - 120

	Type	AKM2G-3 and AKM2G-4
Commutating Channel	2-	8 Pole 45°m
Moment of Inertia (kg-cm ²)	2-	0.0048

Absolute Digital Feedback Options

HIPERFACE DSL® (GU)

Type		Multi-Turn "GU"
Frame Size		AKM2G-2, -3 and -4
Number of Absolute Ascertainable Revolutions		4096
Supply Voltage Range		7 to 12
Current Consumption	mA MAX.	150
Operating Temperature	°C MIN/MAX	-40/115
Inertia	g-cm ²	1
Output Interface		SICK HIPERFACE DSL®
Type		EEM37

EnDat Inductive (LD)

Type		Multi-Turn "LD"
Frame Size		AKM2G2, -3 and -4
Revolutions		4096
Input Voltage	Vdc	3.6 to 14
Current Consumption	mA Typical	5 V: 115 (without load)
Operating Temperature	°C MIN/MAX	-40/115
Inertia	kg-m ²	0.3x10 ⁻⁶
Output Interface		HEIDENHAIN EnDat 2.2/22
Type		EQI 1131

Resolver Feedback Option (R-)

Resolver Data	Units	AKM2G-3 and -4
		1 Speed
Input Voltage	V _{RMS}	7.0
	k Hz	10
Input Current Max.	mA	50
Transformation Ratio	N/A	0.5 ±10%
Null Voltage	mV _{RMS}	30
Max. Error (pk-pk)	MINS.	18
Phase Shift	Degrees	0
Operating Temperature	°C	-55° to 155°
Rotor Inertia Max.	kg-cm ²	0.046

Resolver Winding Configuration

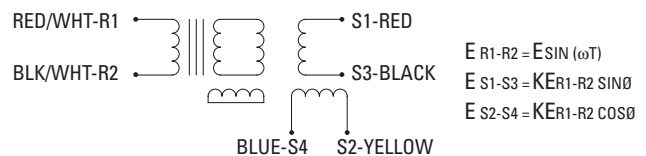

Resolver Alignment

With positive DC current into phase W and out of phase V (U floats) the resolver is aligned to electrical ±5 counts. ie. Voltage S1-S3 set to null voltage S2-S4 max in phase with reference (R1-R2).

AKM2G Servo Motor Connector Pinouts

C & G Dual Connector Pinouts – AKM2G low voltage servo motors

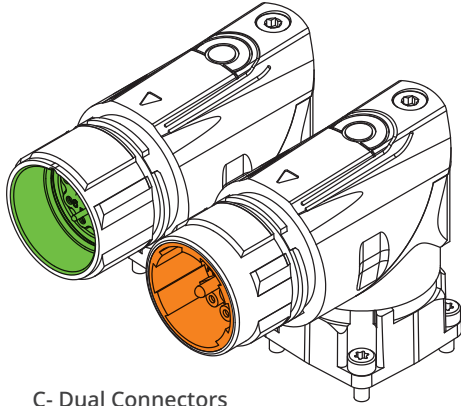

C- Dual Connectors

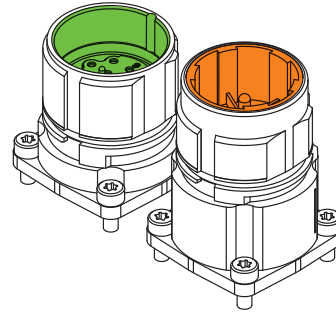

G- Dual Connectors

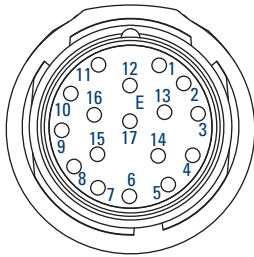

Commutating Encoder Feedback

Pin	Function
1	B
2	\bar{B}
3	A
4	\bar{A}
5	Z
6	\bar{Z}
7	GND
8	Thermal Sensor +
9	Thermal Sensor -
10	Vcc
11	N/C
12	N/C
13	N/C
14	N/C
15	U
16	V
17	W

Resolver Connector

Pin	Function
1	N/C
2	Thermal Sensor +
3	S4, COS-
4	S3, SIN-
5	R2, REF-
6	Thermal Sensor -
7	S2, COS+
8	S1, SIN+
9	R1, REF+
10	N/C
11	N/C
12	N/C

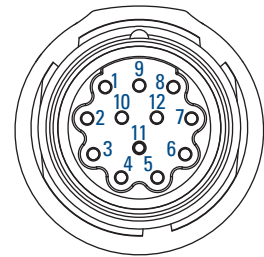

Shield is Not Connected at Motor End.
On motor mounted connectors, the thermal sensor lead colors are (+) Blue, (-) Black.

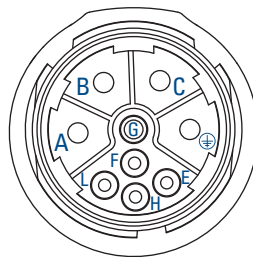

Power Connector

Pin	Function
A	U
⊕	PE
C	W
B	V
F	Brake +
G	Brake -
E	N/C
H	N/C
L	N/C

Shield Connected to Motor
Ground Internal to Motor

D- Connector Pinouts – Hybrid combined power and feedback for DSL and EnDat for AKM2G low voltage servo motors

D- Dual Power + HIPERFACE DSL® Connector Option

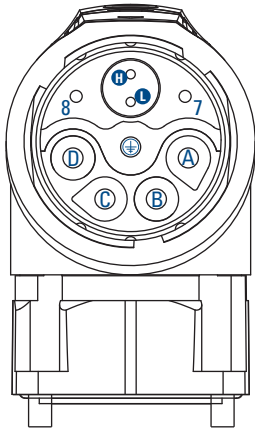

Power + DSL

Pin	Function
A	Phase U
B	Phase V
C	Phase W
D	N/C
⊕	PE
8	Brake +
7	Brake -
L	DSL -
H	DSL +

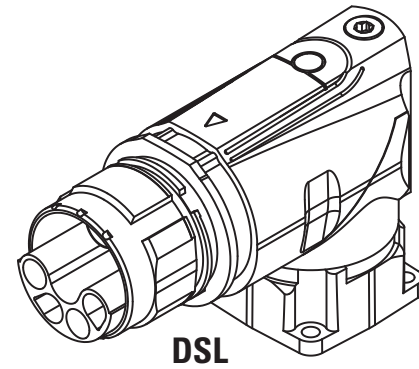

D- Dual Power + EnDat® Connector Option

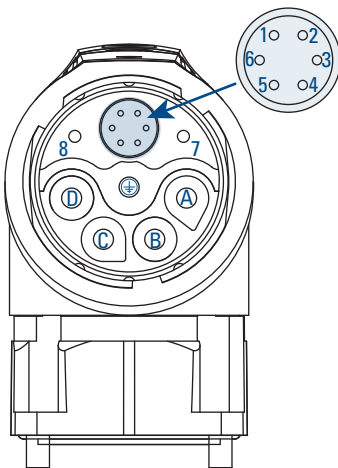

Power + EnDat

Pin	Function
A	Phase U
B	Phase V
C	Phase W
D	N/C
⊕	PE
8	Brake +
7	Brake -
1	Up
2	0 V
3	Data +
4	Data -
5	Clock +
6	Clock -

Ethernet

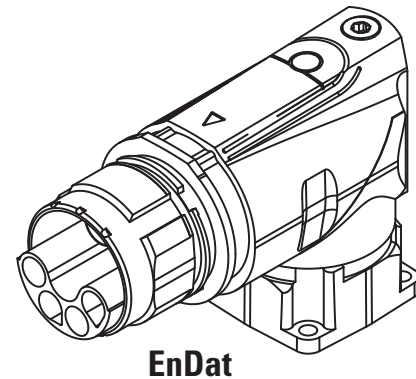

Kollmorgen Cables Offer the Complete Solution



Kollmorgen offers complete cable solutions for connecting drives and motors. This includes static, low cost cable sets for simple applications to high bend, high flex, hybrid cables that combine feedback and power in one cable.



<https://www.kollmorgen.com/en-us/products/accessories/cables/motor-power-and-feedback-cables/motor-power-feedback-cables>

AKM2G Performance Curve Overview

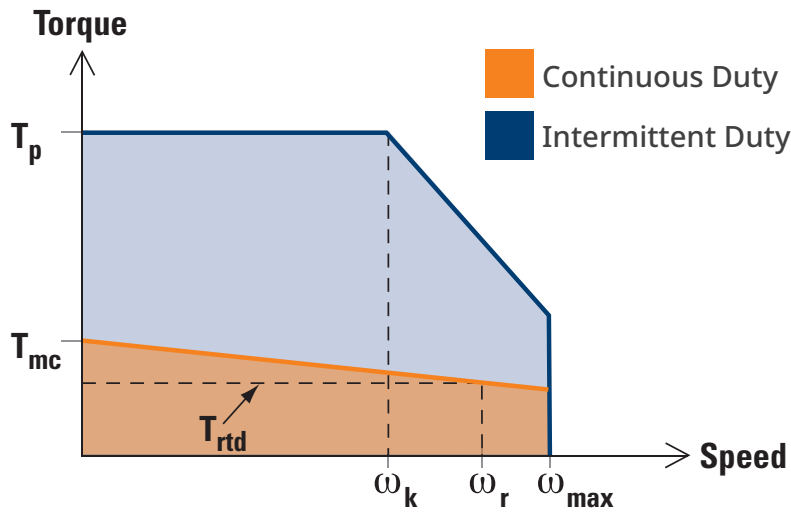

Definitions	
T_p	- Peak torque
T_{mc}	- Maximum continuous torque
T_{rtd}	- Continuous rated torque (torque at rated power)
ω_{max}	- Maximum speed
ω_r	- Rated speed (speed at rated power)
ω_k	- Speed at knee in peak envelope (intersection of system peak torque with voltage limit line)

Curves shown on the previous pages are calculated based on resolver/non-brake/non-seal motors only. For other motor curves please refer to Kollmorgen's Motioneering Application Sizing programs, the Kollmorgen website Performance Curve Generator or contact Kollmorgen customer support for assistance.

How to Build a Servo Drive and Motor System

Performance data on the following pages is designed to help you select the optimum brushless servo motor.

Drive and Motor Performance Curves

The performance characteristics of a brushless servo system (motor/drives combination) are described by a torque/speed operating envelope. As shown above, the shaded areas of the curve indicate the continuous duty and intermittent duty zones of the system.

Continuous Duty Zone

The continuous duty zone is bordered by the maximum continuous torque line up to the intersection with the intermittent duty line. The continuous zone torque line is set by either the motor's maximum rated temperature, or the drives' rated continuous current output, whichever is less. The system voltage limit line is set by the voltage rating of the drives, the line voltage supplied, and the motor winding. The system can operate on a continuous basis anywhere within this area, assuming the ambient temperature is 40°C or less.

Intermittent Duty Zone

The intermittent duty zone is bordered by the peak torque line and the system voltage limit line. The peak torque line is set by either the drives' peak current rating, which the drive can produce for a limited time, or the maximum rated peak current for the motor, whichever is less. Refer to the Rating Data on the following pages. Note: Higher torque levels may be achievable at higher power levels.

Consult Kollmorgen Customer Support for more details. The system voltage limit line is set by the voltage rating of the drive, the line voltage applied and the motor winding. Operation in the intermittent zone must be limited to a duty cycle that will produce an RMS system torque falling within the continuous duty area. The RMS torque value is a function of the magnitude of the intermittent torque and the percentage of the time spent at that torque.

AKM2G Servo Motor Nomenclature

AKM[®]2G Low Voltage Brushless Servo Motor

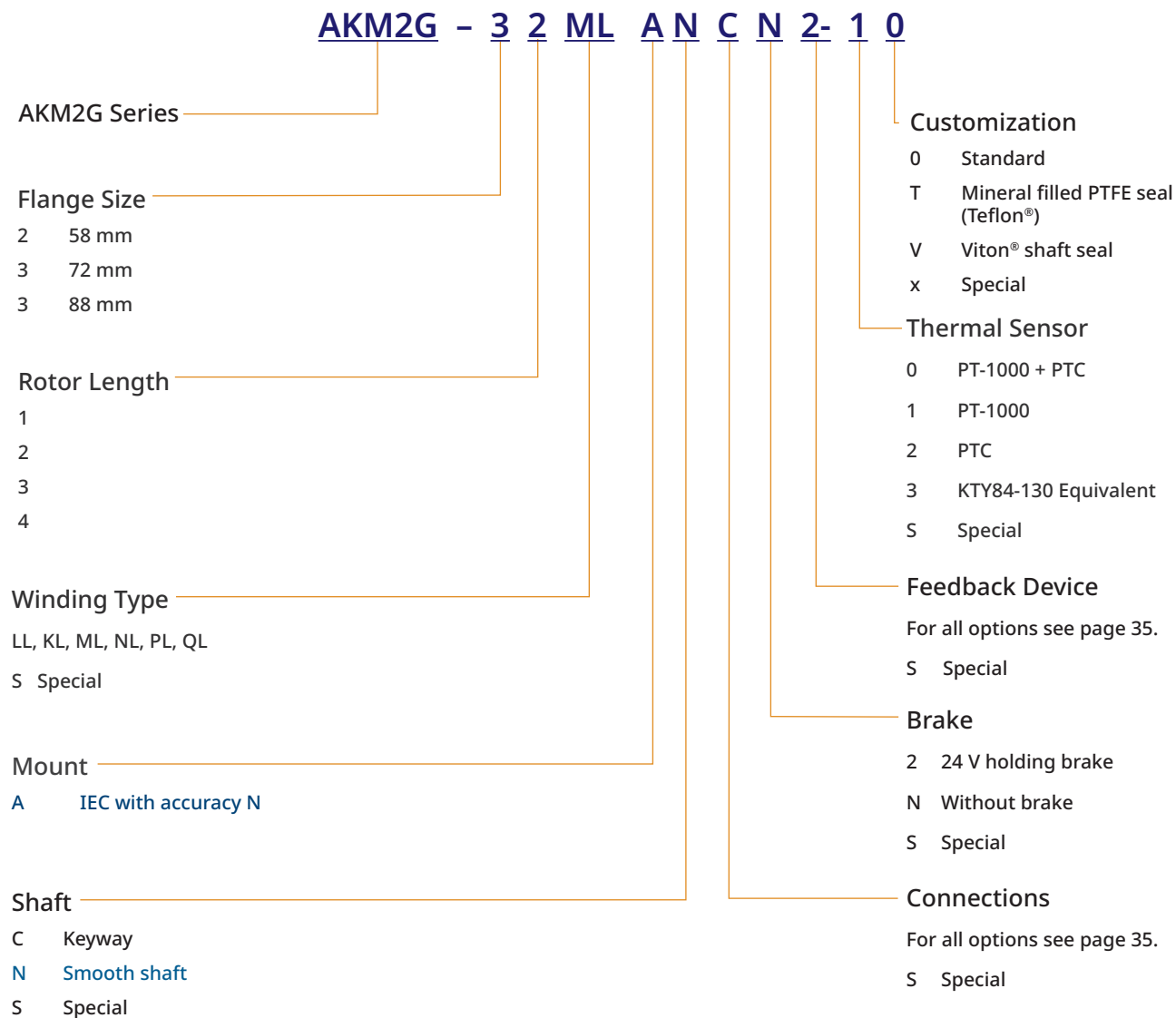

Note: Options shown in blue text are considered standard.



Notes

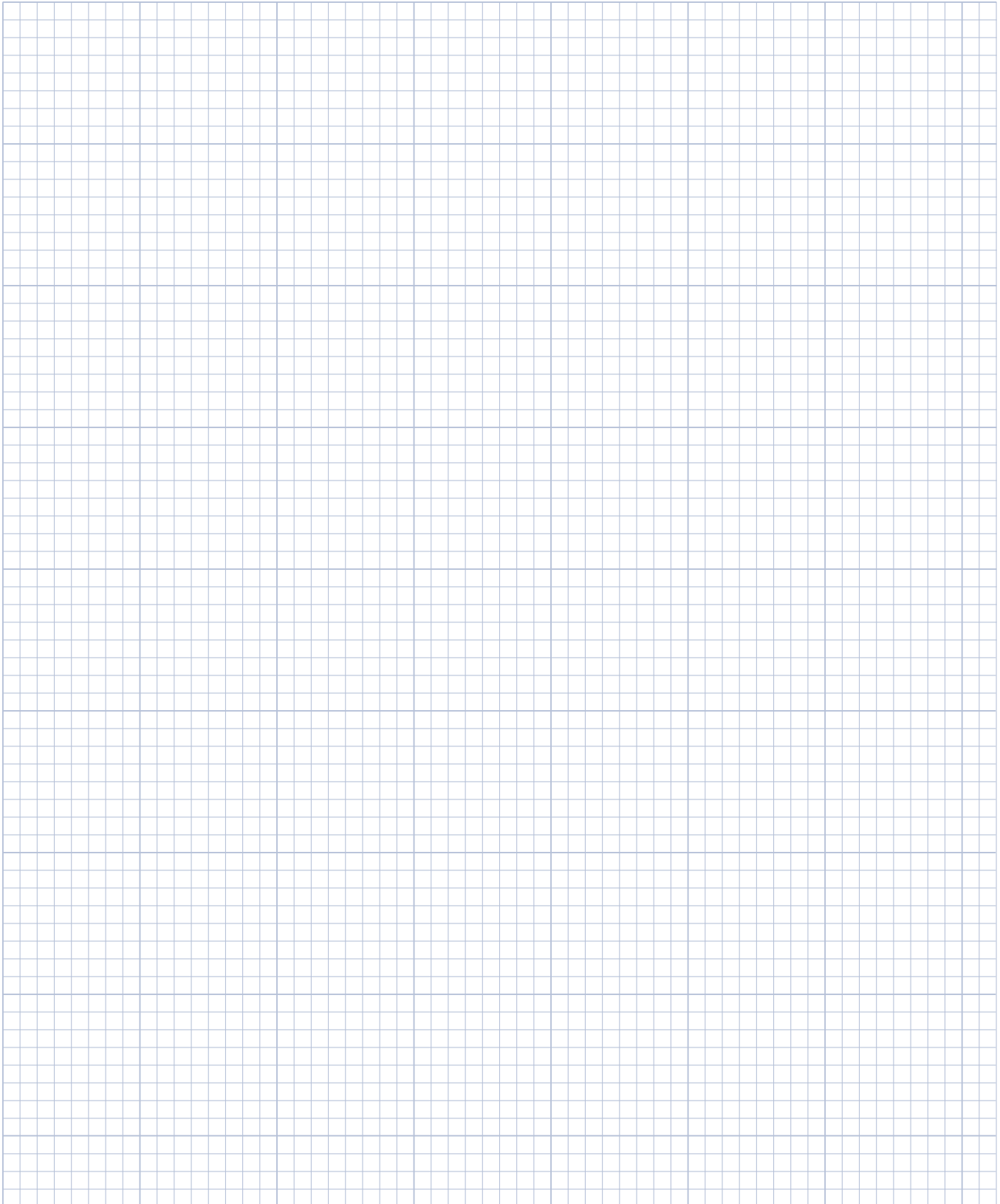

0.125 inch divisions

Kollmorgen Solutions

Automation and Motion Control



Self-Help Tools

Motioneering® Online



Size and select the right product for your application needs

Drawing Generator



Provide TBM/KBM/AKM 2D and 3D drawings in many popular formats

Performance Curve Generator

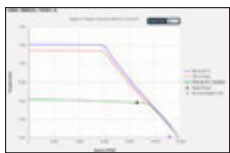

Optimize TBM/KBM/AKM windings using customer supplied environmental and drive information

Product Selector



Choose right product for your application needs

Kollmorgen Developer Network



Find Answers to many key technical questions or start your own session

Stepper Optimizer



Select the most efficient stepper solution for your application

More Expertise for a More Successful Machine

Our global engineering, service and support network provides deep knowledge of all the major industries that rely on advanced motion control and automation technology. We offer world-class engineering expertise, self-service design tools, personalized field service, and easy access to our design, application and manufacturing centers in strategic locations across the globe.

About Kollmorgen

Kollmorgen has more than 100 years of motion experience, proven in the industry's highest-performing, most reliable motors, drives, linear actuators, gearheads, AGV control solutions and automation platforms. We deliver breakthrough solutions that are unmatched in performance, reliability and ease of use, giving machine builders an irrefutable marketplace advantage.

Kollmorgen is a brand of Altra Industrial Motion Corp. (NASDAQ: AIMC), a premier global designer and producer of a wide range of motion control and power transmission solutions. With engineered components and systems that provide the essential control of equipment speed, torque, positioning, and other functions, Altra products can be used in nearly any machine, process or application involving motion.

KOLLMORGEN

www.kollmorgen.com

Specifications are subject to change without notice. It is the responsibility of the product user to determine the suitability of this product for a specific application. All trademarks are the property of their respective owners

© 2020 Kollmorgen Corporation. All rights reserved